



**Spin-Offs from
Public Research Organisations in Germany:
A Comprehensive Analysis based on
Bibliometric, Patent, Website and
Company Register Data**

Rainer Frietsch, Denilton Darold, Maria Karaulova, Sonia Gruber, Peter Neuhäusler
(Fraunhofer ISI)

Christian Rammer, Thorsten Doherr, Julian Dörr, Sandra Gottschalk
(ZEW - Leibniz Centre for European Economic Research)

Karlsruhe and Mannheim

July 2021

Content

1	Executive Summary	1
2	Introduction	3
2.1	Objective	3
2.2	Definitions	4
2.3	Types of Spin-offs	5
2.4	Structure of the report	7
3	International Comparison of Spin-offs from Public Research Organisations and Universities	9
3.1	Methods and data	9
3.2	Results	11
4	Interviews with spin-off active research organisations	20
4.1	Introduction	20
4.2	Interviewee selection.....	20
4.3	Method and Data.....	21
4.4	Rationale and strategic approaches to spin-off support.....	21
4.5	Key challenges and strategies to overcome them	23
4.5.1	Pre-seed phase	25
4.5.2	Seed phase	26
4.5.3	Scaling-up phase	26
4.5.4	Regulation, Institutions and culture	27
4.6	Spin-offs from universities and public research organisations	28
5	Identifying Spin-Offs from Public Research Organisations in Germany	30

5.1	Method	30
5.1.1	Basic Data	30
5.1.2	Fraunhofer ISI Approach	33
5.1.3	ZEW Approach	40
5.1.4	Quality Control	44
5.2	Results	46
5.2.1	Trends	48
5.2.2	Structural Characteristics of knowledge-based Spin-offs	51
5.2.3	Comparison with Existing Spin-off Lists	58
6	Summary and Conclusions	61
	References	65

Tables

Table 1:	Types of spin-offs and start-ups from RPOs	7
Table 2:	Coverage of the main challenges of spin-off support and strategies to address them in the interviews	24
Table 3:	Results of a broad matching of firm websites mentioning PROs or universities	43
Table 4:	Number of knowledge-based spin-offs from German PROs and universities 2010 to 2019 by identification approach	46
Table 5:	Number of knowledge-based spin-offs from German PROs 2010 to 2019 by PRO.....	47
Table 6:	Regions with the largest number of knowledge-based spin-offs from German PROs founded during 2010 and 2019.	57
Table 7:	Number of knowledge-based spin-offs from German PROs 2010 to 2019: results of the present study and spin-offs documented by PRO headquarters.....	58
Table 8:	Overlap of PRO knowledge-based spin-offs identified in the present study and spin-offs documented by PRO headquarters	59
Table 9:	Overlap of PRO knowledge-based spin-offs identified in the present study and spin-offs documented by PRO headquarters	60
Table 10:	Indicators on knowledge transfer from PROs and universities in Germany.....	63

Figures

Figure 1:	Absolute number of IP- or license-based spin-offs from PROs in Germany, 2011-2019.....	13
Figure 2:	Absolute number of spin-offs by German PROs in comparison to selected US-American institutions, 2011-2019	15
Figure 3:	Absolute number of spin-offs by German PROs in comparison to selected European institutions, 2011-2019	16
Figure 4:	Absolute number of spin-offs for a selected set of national and international organisations, 2017-2019	17

Figure 5:	Average number of spin-offs per 1,000 employees for a selected set of national and international organisations, 2017-2019	18
Figure 6:	Data analytics process of the Fraunhofer ISI approach ...	34
Figure 7:	First round selection	37
Figure 8:	Second round selection.....	39
Figure 9:	Probability tree for drawing a namesake vs. staying unique	41
Figure 10:	Number of knowledge-based spin-offs from German PROs and universities 2010 to 2019	48
Figure 11:	Ratio of knowledge-based spin-offs to researchers at German PROs and universities 2010 to 2019.....	49
Figure 12:	Number of knowledge-based spin-offs from German PROs 2010 to 2019 by PRO.....	50
Figure 13:	Status of economic activity of knowledge-based spin-offs from German PROs and universities founded during 2010 and 2019 by the end of 2020	51
Figure 14:	Industry distribution of knowledge-based spin-offs from German PROs and universities founded during 2010 and 2019	52
Figure 15:	Size of knowledge-based spin-offs from German PROs and universities founded during 2010 and 2019	53
Figure 16:	R&D activity of knowledge-based spin-offs from German PROs and universities founded during 2010 and 2019....	54
Figure 17:	Distribution of knowledge-based spin-offs from German PROs and universities founded during 2010 and 2019 by German states.....	55
Figure 18:	Knowledge-based spin-offs from German PROs founded during 2010 and 2019 per researcher, by German states	56

1 Executive Summary

- Spin-offs from public research organisations (PROs) and higher education institutions (HEIs) are expected to **generate innovations**, open-up **new markets**, increase the **competitiveness** of the business sector and create **new jobs**. In consequence, they have gained attention by policy makers in recent years.
- We analyse spin-offs from two different angles: First, we examine **IP-based spin-offs** as they are usually monitored by PROs and HEIs. Second, we develop a new method to identify different types of spin-offs, denoted as **knowledge-based spin-offs**. They are defined as new firms founded by individuals who previously worked as researchers at HEIs or PROs and which rest on a knowledge-based or innovation-driven business model.
- The **IP-based spin-offs** from German PROs have been **growing by 7.3% per year** in the period 2011-2019, the ones by Fraunhofer even at a rate of 12.7% per year.
- Leading German HEIs and PROs show similar levels of IP-based spin-off activity like most of the prestigious and productive research organisations and universities in Europe and the USA.
- Nowadays, most **knowledge-based spin-offs** from PROs and HEIs **offer services**, particularly ICT services (computer programming and software development), engineering services and R&D services. Less than 20% belong to the **manufacturing sector**.
- The vast majority of knowledge-based spin-offs founded during 2010 and 2019 was **still economically active** by the end of 2020 (80%).
- **Regional differences** in the creation of spin-offs are evident in Germany, with Berlin, Munich, and Karlsruhe being the most vivid spots.
- Organisations that are central actors in their innovation ecosystems have more incentives to nurture spin-offs that grow into **proper businesses (survival orientation)**. PROs and HEIs also aim at **learning from both successes and failures** for better supporting their spin-offs (**learning orientation**).
- Some PROs or HEIs jointly work with external actors to build an **attractive entrepreneurial ecosystem** as a part of their mission.
- **External expertise and consultancy** was repeatedly mentioned as an important mechanism to improve the team of an innovative spin-off and make it a success.
- **Red tape and outdated regulation** were mentioned as persistent, wicked problems.
- Availability of **venture capital and investment is not a problem per se**, but making them **visible** to investors. **Scale-up investment** was noted as a serious issue for research organisations located outside of the major clusters and financial centres. In addition, investors might be reluctant in case of science-based innovation, because **research-intensive companies take relatively longer time** to generate returns.

Recommendations

Establishing an entrepreneurial culture in PROs and HEIs continues to be of high importance. **Internal spin-off programmes** in the organisations deserve to be strengthened. **Public funding programmes** like EXIST should be continued and consistently linked to other national (e.g. WIPANO) or regional programmes (e.g. spin-off support by States).

Spin-offs should be regarded as part of a **broad range of mechanisms to exchange IP and other knowledge** generated at HEIs and PROs with firms and the society. Contract research, collaborative research, joint research infrastructures, licensing, transfer of ownership as well as open knowledge transfer (e.g. open access, open source, open data) should be seen as equally relevant ways of knowledge transfer. HEIs and PROs should therefore follow and encourage a multi-channel approach.

A **cultural shift** in the strategic departments of PROs and HEIs towards a **broader definition** of knowledge transfer by start-ups could strengthen the role of this transfer channel. Not only IP-based, but also knowledge-based start-ups should get attention and be acknowledged as spin-offs. However, a distinction between different types of start-ups should also be kept to offer tailor-made support.

A **harmonisation of the definitions** and a **regular monitoring** of all kinds of spin-offs should be implemented as this will help to better understand the influencing factors on firm foundations as well as their economic, technological and societal impact.

The most successful institutions are embedded in **entrepreneurial ecosystems**, where not only actors work together, but where relevant factors amalgamate, namely scientific knowledge, entrepreneurial spirit, human capital, venture capital, as well as regulatory frameworks and demand. PROs and HEIs should be enabled to create such ecosystems.

Collaboration beyond institutional borders with respect to entrepreneurial activities and the creation of spin-offs should be further supported. Joint incubators, joint programs and thereby also joint spin-offs need to be enacted.

The **regulatory framework** should be adapted to the real-world needs of founding-interested researchers. Regulatory sandboxes, especially with respect to the use of scientific infrastructures and the reduction of the limits of the competition law, should be ventured and - if successful and scalable - rolled out nationwide. German government should try to influence international and transnational regulation in this respect.

2 Introduction

2.1 Objective

Spin-offs from public research organisations (PROs) in Germany have gained increasing attention in recent years as a way to transfer research results from these organisations into commercial use. Such spin-offs are expected to generate innovations, open-up new markets based on new technologies, increase the competitiveness of the business sector and create new jobs. Spin-offs are hence seen as an important mechanism to obtain economic returns from the government's investment into PROs.

Assessing the relevance of this transfer mechanism is complicated by the fact that no reliable statistics on the number of such spin-offs exists in Germany. While many PROs keep record of some spin-offs – particularly in case the PRO holds a share in the spin-off or has contractual relations with the spin-off, e.g. when providing or transferring intellectual property (IP) –, there may be many more spin-offs by researchers from PROs which are not known to the PRO. At the same time, statistics on start-ups in Germany do not contain information on the background of entrepreneurs or the circumstances of firm formation that would allow to identify spin-offs from PROs.

In order to close this information gap on the actual number of such spin-offs from German PROs, the Fraunhofer Society and the Leibniz Association commissioned a research project to the Fraunhofer Institute for Systems and Innovation Research (Fraunhofer ISI) and the Leibniz Centre for European Economic Research (ZEW). The research project developed a novel approach for identifying spin-offs. The basic idea is to link the names of researchers from PROs with the names of firm founders. In the absence of complete and dynamic list of all researchers at PROs (and universities) in Germany, publicly available data bases on scientific publications and patent applications were employed to establish a lists of researchers at PROs and universities in Germany. There are several advantages of using bibliometric and patent data for identifying researchers: It is easy to identify researchers who in the meantime left the organisation (dynamic dimension), researchers can easily be assigned to disciplines and technologies, and one can establish a start and end date of research activity in terms of publications and patenting.

A main challenge of this approach is to avoid false positives, i.e. linking researchers and firm founders of the same name who are actually two different individuals. To ensure that a researcher and a firm founder with the same name are the identical person, we combine bibliometric information (e.g. location of the author, academic discipline, time of publication, co-authors), patent information (e.g. location of the applicant, field of

technology, time of filing, co-inventors), company characteristics (e.g. location of the firm, time of foundation, industry, business activity) as well as information from company websites (e.g. mentioning of PROs, text associated to text used in abstracts of articles or patents). Information from publicly available company registers is used to obtain data on structural characteristics of the spin-offs.

The aim of this study is to identify spin-offs from four major German PROs (Fraunhofer Society, Leibniz Association, Max Planck Society, Helmholtz Association) as well as from German universities that were founded in Germany in a comprehensive way for the years 2010 to 2019. Spin-offs from German PROs and universities that were founded in other countries are not covered by this study. The same is true for spin-offs founded in Germany by researchers from incubator organisations abroad.

The output of the project is a database on spin-offs that contains a number of basic characteristics for each spin-off. This database can be used to monitor the development of the spin-offs over time as well as their economic performance. Such analyses are essential to better understand the contribution of spin-offs for knowledge and technology transfer between public research and the business enterprise sector in Germany.

2.2 Definitions

This study uses a number of key terms which are defined as follows:

Spin-off: A new firm founded by individuals who previously worked as researchers at universities or public research organisations and which rests on a knowledge-based or innovation-driven business model.

Researcher: A person who published scientific articles (documented in the Scopus database) or patented technology at a public research organisation or university.

Public Research Organisation (PRO): A research performing organisation that is either owned by the government or receives a significant share of funding from the government and that aims –at least partially – at providing research results as a public good. In Germany, PROs include four large organisations (Fraunhofer Society, Leibniz Association, Max Planck Society, Helmholtz Association) as well as a number of independent research institutes and government authorities with research functions. This study focuses on spin-offs from one of the four large organisations.

University: An organisation that provides tertiary education services. In Germany, the university sector includes various types of public and private higher education institutions (HEIs): general and specialised universities, universities of applied sciences ("*Fachhochschulen*") and other HEIs. In this study, all types of HEIs are considered and denoted by the term "university".

2.3 Types of Spin-offs

Spin-offs from PROs can include a wide variety of firm foundations. One useful way to classify spin-offs is with respect to the type of intellectual property (IP) from the PRO a spin-off uses in its business activities. Four main types may be distinguished:

- **IP-based spin-off:** The main purpose of the spin-off is to commercialise IP that has been generated at the PRO based on an IP contract between the PRO and the spin-off. PROs may bring in their IP either by taking a share in the company or by selling or licensing-out the IP to the spin-off. IP-based spin-offs include both firms that are entirely owned by the PRO, joint ventures between the PRO and other firms or individuals, and firms founded by researchers from the PRO based on an IP contract with the PRO. In this study, only IP-based spin-offs involving a researcher in the founding team are included in the analysis.
- **Research-based spin-off:** A start-up by researchers from PROs with the main purpose to commercialise results of research and development (R&D) activities that were performed by the researchers at the PRO, but not involving an IP contract between the spin-off and the PRO. Such spin-offs may occur, for example, in case the R&D results cannot be protected by legal measures on which an IP contract can be based, or in case the PRO is not interested in establishing an IP contract.
- **Expertise-based spin-off:** A start-up by researchers from PROs that rests on the individual capabilities and competencies of the founders that are not the direct result of an R&D activity, but rather represent the accumulated knowledge of researchers obtained during their work at the PRO. Such knowledge may include methods, contacts and networks and other types of work experiences.
- **Other spin-off:** A start-up by researchers from PROs which is not intended to commercialise R&D results or knowledge generated or obtained during the researchers' work at the PRO. Such spin-offs are often motivated by the researchers' desire to work independently, to explore new ideas or to enter into a new phase of their personal development. While such spin-offs are not directly linked to the transfer of knowledge from the PRO, they nevertheless may

contribute to an indirect knowledge transfer in case the knowledge obtained by the founder at the PRO is utilised for developing the spin-off's business activities at a later stage in the firm's development. This will particularly be the case when the spin-off follows a knowledge-based or innovation-driven business model.

In addition to the four types of spin-off, it is important to note that there are also two other types of start-ups originating from PROs or universities that are sometimes considered as spin-offs from the incubator organisations' point of view but are excluded in this study:

- **Student/graduate start-ups:** A start-up founded by students or graduates of a university who were not employed at the university. While these kinds of companies might occur in the full range of industry sectors, they more often than not focus on service and consultancy. We exclude these kinds of start-ups for two reasons. First, these start-ups very rarely emerge from research activities, but utilise knowledge obtained from teaching or are simply motivated by the personal interest of students to become entrepreneurs. They are typically not contributing to the transfer of research results produced at PROs. Secondly, most PROs do rarely teach or graduate students so that taking them into account harm the comparability of results for PROs with those for universities.
- **Funded start-up projects:** Projects by researchers or students/graduates intended to result in a start-up that receive financial or other support by PROs or universities. When researchers or students/graduates plan to start their own business, PROs and universities often provide funding or infrastructure and consultancy support to these individuals, partly from own funds, partly using government programmes (such as EXIST in the case of Germany). The potential founders need to have a link to the organisation to be eligible for the training/consultancy, e.g. as student, graduate, alumni or staff member. Some universities and PROs report the supported founders as their spin-offs. In this study, they are only included in case a researcher is involved and the start-up project resulted in a firm foundation. Projects that did not result in the foundation of a firm as well as firm foundations by students, graduates and alumni are not included.

The four types of spin-offs do not only differ with respect to whether they are intended to commercialise R&D results from PROs, but also with respect to being monitored by the PRO (Table 1). Typically, PROs very closely monitor IP-based spin-offs and hence have a complete overview about the number and development of such spin-offs. This is not necessarily the case for research-based spin-offs. While these spin-offs also aim at commercialising R&D, they do not have a contractual relation to the PRO. PROs will know about them in case the firm is founded directly after leaving the research

organisation (and even more so if the firm is founded while the researcher is still employed at the PRO). But there are also many cases of a longer time span between leaving work at the PRO and founding a firm, e.g. if a researcher first moves to industry and only later – based on market experience obtained during the industry job – founds a spin-off (see Egelin et al. 2003). Under such circumstances, it is less likely that the PRO will be aware of the spin-off. For experience-based spin-offs and other spin-offs, such a situation is more likely to occur.

Table 1: Types of spin-offs and start-ups from RPOs

Type of spin-off/start-up	Commercialisation of R&D is purpose of the spin-off	Monitoring of spin-off by PRO	Involvement of researcher	Covered in this study
IP-based spin-off	yes	yes	partly	partly
Research-based spin-off	yes	often	yes	yes
Expertise-based spin-off	partly	rarely	yes	yes
Other spin-off	no	no	yes	partly
Student/graduate start-ups	rarely	no	no	no
Funded start-up projects	rarely	often	partly	no

Source: ZEW

In this study, we attempt to capture all four types of spin-offs, but exclude start-ups. For the group of other spin-offs, however, we aim at focussing on those spin-offs that follow a knowledge-based or innovation-driven business model while largely ignoring spin-offs that have little or nothing to do with utilising knowledge or innovating.

2.4 Structure of the report

In the following chapter 3, a national and international comparison of spin-offs from PROs and universities is presented, employing the IP-based spin-off definition. As mentioned above, this type of spin-offs are what research organisations monitor most closely and therefore are able to report them. In most cases, these spin-offs enter the official statistics and are therefore most often available and broadly comparable across countries and organisations. Chapter 4 summarises the findings from a number of

interviews with international organisations - both representatives directly from the organisation or the adjacent transfer office - reflecting on the framework conditions they face, the strategies they have, and the challenges they deal with. Chapter 5 introduces the methods developed in this study to identify what we call 'knowledge-based' spin-offs, a term that intends to cover the three types of IP-based, research-based, and expertise-based spin-offs introduced above. In the second section of chapter 5 structures and trends of the so identified knowledge-based spin-offs are presented. Chapter 6 summarises and concludes.

3 International Comparison of Spin-offs from Public Research Organisations and Universities

In the following, start-up figures of German PROs are subject to an international comparison with start-up and innovation-intensive institutions in Europe and the USA. The German public research organisations (PROs) will be analysed alongside a selected group of international organisations. At the international level, universities and research organisations were selected that had a high number of start-ups in absolute terms.

3.1 Methods and data

The data on non-university research institutions (PROs) in Germany were taken from the monitoring report of the Pact for Research and Innovation (PFI).¹ Numbers of employees of the PROs were extracted from the data portal of the BMBF.² The data of the German and European higher education institutions were collected through internet research (mostly "Facts & Figures") and from annual reports of the international PROs, universities or associated transfer institutions. For the universities in the USA, the "Statistics Access for Technology Transfer" (STATT)³ database of the Association of University Technology Managers (AUTM) was used. The consolidated database is based on a regular survey of all universities in North America (USA and Canada) and contains information on, start-ups, budgets, patent applications and licensing income. The IPEDS figures (Integrated Postsecondary Education Data System)⁴ by the National Center for Education Statistics (NCES) were used to standardise the start-up figures based on employees.

The definitions of start-ups reported by different organisations differ in part between the data sources and are therefore not directly comparable in all cases. In the context of the Pact for Research and Innovation (PFI), for example, only those spin-offs are counted that are based on intellectual property (generally patents) of the institutions or are equity-based. A similar definition is also used by most German HEIs, although in the clear majority of cases the basis is intellectual property and less often participation. The definitions applied by the TU Munich or by RWTH Aachen, for example, are broader and include all technical-scientific start-ups supervised by the TU's start-up advisory service

1 GWK, Pakt für Forschung und Innovation - Monitoring-Bericht 2020, S. 134;
https://www.gwk-bonn.de/fileadmin/Redaktion/Dokumente/Papers/GWK-Heft-68_Monitoring-Bericht-2020-Band_I.pdf

2 <https://www.datenportal.bmbf.de/portal/de/K17.html>

3 <http://www.autmsurvey.org/statt/index.cfm>

4 <https://nces.ed.gov/ipeds/>

(at the TTO) and therefore include not only university IP-based start-ups, but also start-ups by alumni and former employees. In the case of RWTH, start-ups involving a broad group of employees, students and alumni are also recorded, whereby a focus is placed on corporations. Innovative and active business activity is seen as a prerequisite in the recording. However, the data from TU Munich and RWTH are not directly comparable with the other national and international data. In consequence, these organisations are not taken into account for the international comparison provided in this study.

AUTM's definition in the survey of figures for its North American member institutions also focuses on the licensing of intellectual property,⁵ but is thus somewhat narrower than the definition in the PFI, for example, where equity investments are also taken into account. However, none of the organisations analysed in this compilation have a large number of exclusively equity-based spin-offs, often in return for equity investments and licensing.

BOX: In Germany, the EXIST funding scheme supports university and non-university PRO researchers (as well as students or graduates) in the pre-foundation phase. Additional funding programs might also address the pre-foundation phase, but also seed funds like the High-Tech Gründerfond⁶ (HTGF, High-Tech Seed Fund). Fraunhofer, for example, initiated internal funding schemes and mechanisms that intend to identify interested and capable founders and to support them in all stages of the process from the idea to the foundation.⁷ Due to European and German regulatory frameworks - this concerns procurement law, subsidy regulations, and in particular competition law (single market regulation) - the support must end when they go public. Providing IP or licenses is then the usual link between the newly founded company and the research institution. In seldom cases, the PRO takes equity.

The start-up figures of various European HEIs such as ETH Zurich, TU Delft or KU Leuven follow a corresponding definition of an IP-based count. In the UK, a distinction is made between spin-offs (IP-based), start-ups (not IP-based, but founded by university staff or recent graduates) and "other" (non-profit companies or student start-ups).⁸ In this study, only spin-offs, i.e. IP-based spin-offs, are considered. The University of Oxford calls these "spin-out companies" in its annual reports and also counts them on the basis

⁵ https://autm.net/AUTM/media/Surveys-Tools/Documents/FY19_Survey_Questions_v2.pdf

⁶ <https://www.htgf.de/en/>

⁷ <https://www.fraunhoferventure.de/en/angebote/forschende.html>

⁸ <http://www.spinoutsuk.co.uk/listings/university-listings/default.aspx>

of scientific research owned by the university: "...spinout companies based on academic research generated within and owned by the University of Oxford...".⁹

3.2 Results

In this study, the IP- and license-based numbers reported in different sources have been used for the comparison, as this is the underlying definition used by the four large German PROs that are in the centre of this analysis. Organisations that do not report start-up data resembling this definition were not included in the following analyses.

To start with, the absolute numbers of spin-offs by the four individual organisations are depicted in Figure 1. The PROs show a stable trend or have even increased their numbers of spin-offs per year, beyond annual fluctuations that might occur due to varying levels of ideas, but also due to varying availability and accessibility of (public) funding schemes. The steepest increase with a compound annual growth rate of 12.7% per year in the period 2011-2019 was achieved by Fraunhofer with 26 spin-offs in 2019 and even 30 newly founded companies in 2018. Since 2015, Fraunhofer has the highest output of spin-offs, while Helmholtz took the lead before 2015. The Helmholtz Association had increased its output in the first decade of this century and also in the early years of the second decade. Since 2013 the numbers are rather stable at a level of about 20 IP- and license-based spin-offs per year. The CAGR for Helmholtz is 3.9%.

The spin-offs by the Max-Planck Society also follow a rather stable trend in the observation period with an increase in 2019. The spin-offs by the Leibniz Association have been decreasing between 2012 and 2015, while an increasing trend can be seen between 2015 and 2019, with an obvious catch-up effect of 11 spin-offs in 2016.

While Fraunhofer and Helmholtz are mainly - or by large parts - focusing on applied research and are therefore more prone to technology transfer - spin-offs are just one out of many channels of transfer -, Leibniz and especially Max-Planck are conducting basic research. In consequence, the numbers of annual spin-offs are considerably different between these organisations, with Fraunhofer and Helmholtz at a higher absolute level than Max-Planck and Leibniz. These numbers resemble the different missions of the research organisations and the division of labour and tasks in the German non-university research landscape.

Considering all four PROs in total, a clearly increasing trend with an average annual growth rate of 7.3% per year becomes evident, with retarding moments in 2017 and 2019, but mostly steady increases since 2012 (see Figure 2). This reflects the growing

⁹ <https://innovation.ox.ac.uk/portfolio/companies-formed/>

relevance and sensitivity of the organisations as well as the increased demand by policy makers, accompanied by support policies and political pressure, respectively. The Pact for Research and Innovation (PFI), for example, puts transfer pathways centre stage for the period 2021-2030. Spin-offs by the pact organisations - these are the four non-university research organisations Fraunhofer, Helmholtz, Leibniz and Max-Planck as well as the German Science Foundation (DFG) - are one out of seven channels of transfer into industry and society that are addressed by PFI. The seven channels are 1) contract research, 2) spin-offs, 3) IPR, 4) norms and standards, 5) qualification, 6) infrastructure services, 7) science communication. In addition, the provision of transfer relevant funding and funding programs refers to the DFGs contribution to transfer. While spin-offs were an established transfer channel also in previous phases of the PFI, a new emphasis of this transfer mechanism as well as clear commitments by all PROs to this particular goal applies in the most recent phase IV that just started in 2021. The means to reach this end can be defined by the PROs themselves. Fraunhofer, for example, deepens the already existing internal programs and puts further incentives in place, both for founders as well as the research institute where the idea is rooted. Helmholtz intends to broaden its transfer perspective and aims at increasing the number of non-technology-based start-ups. Internal programs will continue to support interested researchers and also try to link them with international researchers and start-up activities. Furthermore, Helmholtz intends to induce a cultural shift towards more start-ups by offering entrepreneurship trainings. Max-Planck uses mentoring programs in collaboration with industry partners to support potential founders. In addition, lowering thresholds by simplifying the equity and licensing models as well as the continuation and intensification of support and validation programs are meant to increase the number of spin-offs in the coming years.¹⁰

¹⁰ The "contract" underlying the pact is available at (German only):
<https://www.gwk-bonn.de/fileadmin/Redaktion/Dokumente/Papers/PFI-IV-2021-2030.pdf>

Figure 1: Absolute number of IP- or license-based spin-offs from PROs in Germany, 2011-2019

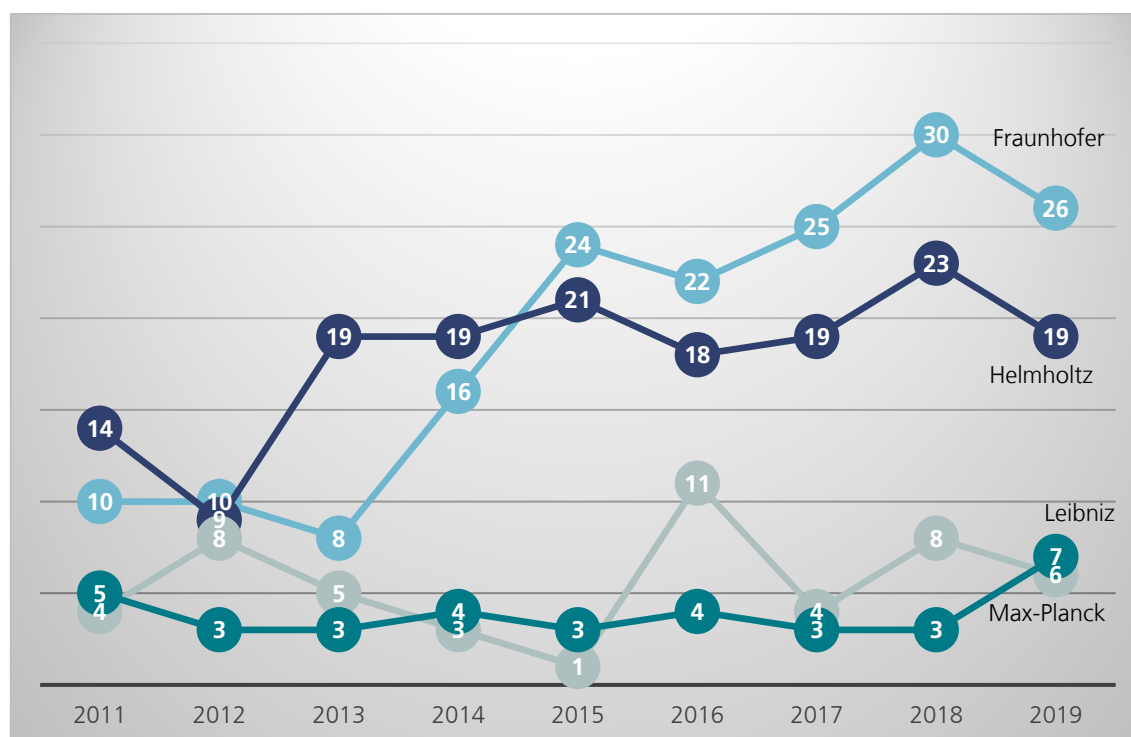

Source: GWK; Fraunhofer ISI calculations.

However, not only in Germany the foundation of new companies is in the focus of transfer and science policy actions. The creation of start-ups has gained importance in most research organisations in Europe, while only a few organisations have explicit growth strategies. CNRS, for example, - one of the biggest research organisations in the world and according to their own reports, the largest producer of scientific publications - currently reaches a level of about 100 start-ups per year, but intends to increase this number by 50% to 150 start-ups per year. "Notre ambition est de passer à 150 start-up créées par an, en ciblant prioritairement des projets à fort potentiel de croissance" (CNRS 2021, p.42).¹¹

At the ETH Zurich about 5-10 IP-based spin-offs occur per year and about 30-35 start-ups, including additional companies that are supported by the ETH's technology transfer office. The numbers of supported companies has been increasing, while the numbers of IP-based start-ups is meandering around 5-10 since 2012. One of the reasons for this is that the ETH follows a kind of quality strategy, like most of the high-level research organisations. It "... asserts that for ETH Zurich it is crucial that promising technology

¹¹ https://www.cnrs.fr/sites/default/files/pdf/RA_CNRS2020_web-compress%C3%A9.pdf.

and ideas arising from basic research are translated to companies with high growth potential, thus creating new jobs. Surviving long-term in the market is a challenge and poses a high risk to the company founders."¹² More proof of this is provided in chapter 4, where interviews with representatives from the most successful international research organisations report of strategic policies and governance that aim at high-quality and highly sustainable foundations over a strict increase of absolute numbers.

Another indication of the growing attention and a proof for the increasing relevance of spin-offs are the trends of the largest universities in the USA (see Figure 2). The largest conglomerate of universities in terms of spin-offs is the University of California System that consists of 10 universities¹³ that sum up to more than 90,000 employees - academic as well as administrative staff. The numbers of spin-offs by University of California System (UCS) have almost steadily been increasing since 2012 and reached a level of more than 100 in 2019. The CAGR between 2011 and 2019 is 7.3% per year, which resembles the growth rate of the total of German PROs in the same period. The German PROs as a total reach about 2/3 of the spin-offs of the UCS with in sum about 82.000 employees. With 45 spin-offs in 2019 and an average annual growth rate of even 10.7% between 2011 and 2019 the University of Texas System, a conglomerate of 8 universities¹⁴ and a cumulated number of 33,000 employees, is among the most dynamic organisations under examination here. MIT, Stanford and CalTech (California Institute of Technology) reach between 21 and 25 spin-offs in 2019. While MIT showed a decreasing trend in the first half of the observation period and an increasing trend in the second half, resulting in an on average steady level, Stanford University exhibits the largest average annual growth rate among all organisations compared here, with a CAGR of 13%.

12 <https://ethz.ch/en/news-and-events/eth-news/news/2020/01/pr-spin-offs-2020.html>

13 These are the following universities and locations: UC Berkeley, UC Davis, UC Irvine, UCLA, UC Riverside, UC San Diego, UC San Francisco, UC Santa Barbara, UC Santa Cruz, UC Merced.

14 These are the Universities of Texas in Arlington, Austin, Dallas, El Paso, Tyler, Permian Basin, San Antonio, Rio Grande Valley

Figure 2: Absolute number of spin-offs by German PROs in comparison to selected US-American institutions, 2011-2019

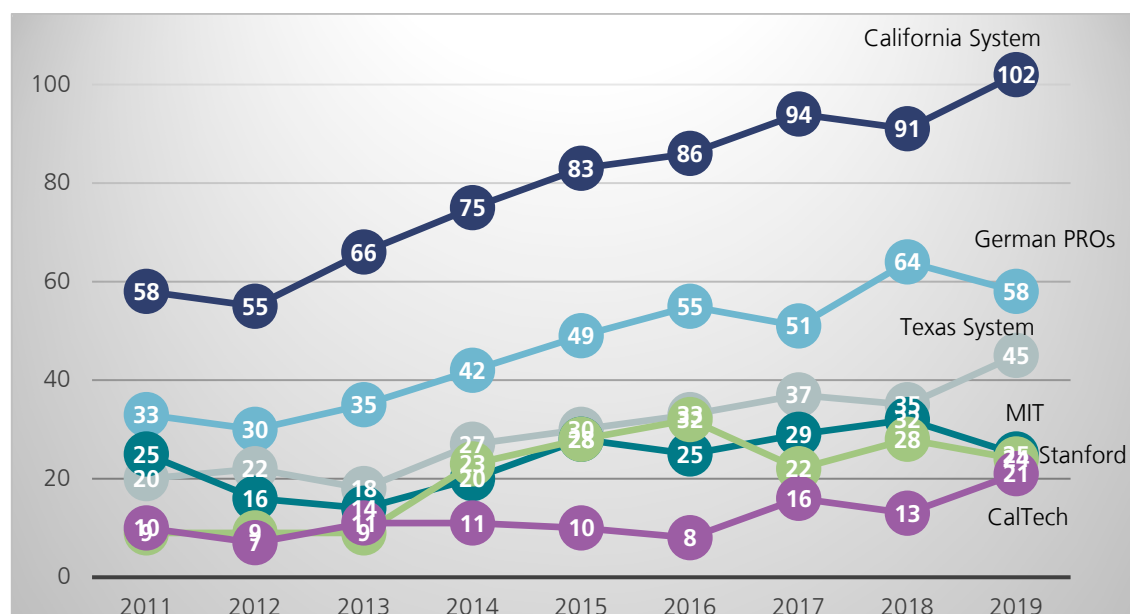

Source: GWK, AUTM; Fraunhofer ISI calculations.

Figure 3 depicts the absolute numbers of spin-offs of German PROs in comparison to selected European organisations. CNRS, as one of the largest research organisations worldwide, reaches the highest absolute numbers with almost 100¹⁵ spin-offs in 2019. EPFL (École Polytechnique Fédérale de Lausanne) is the university with the highest reported numbers of spin-offs per year in this comparison. It shows a slightly increasing trend over the years with a CAGR of 5.5%, but with some fluctuations that followed a rather decreasing trend between 2014 and 2017 and a jump to a higher level in 2018. Oxford University as the representative of the UK in this comparison group, showed an increasing trend up to 2018, but cut the spin-off output almost in half in 2019. For 2020 (data not depicted in Figure 3) the level of 2018 was almost reached again. ETH Zurich and the Spanish organisation CSIC (Consejo Superior de Investigaciones Científicas) each show - apart from fluctuations over the years - a rather stable level of about 10 spin-offs per year.

Several German universities - like the TU Munich, TU Berlin or RWTH Aachen - do not report spin-off numbers according to a comparable definition of IP- or license-based foundations of new companies so that they are not depicted in the figures presented

¹⁵ For CNRS the effective numbers were not reported for each year, but changes of accumulated totals on a yearly basis as well as totals for a period. Reported data was used to calculate annual spin-off numbers and based on the information missing numbers were imputed using linear interpolation. This is why a strictly linear trend appears between 2013 and 2019.

here. One exception of a German university that reports both, data based on the narrower definition of IP and licensing as well as on the broader definition of support of the founders in the pre-foundation phase, is the KIT (Karlsruhe Institute of Technology). Applying the more narrow definition, KIT reports about 10 spin-offs per year (not displayed in Figure 3), which is a level similar to ETH Zurich.

Figure 3: Absolute number of spin-offs by German PROs in comparison to selected European institutions, 2011-2019

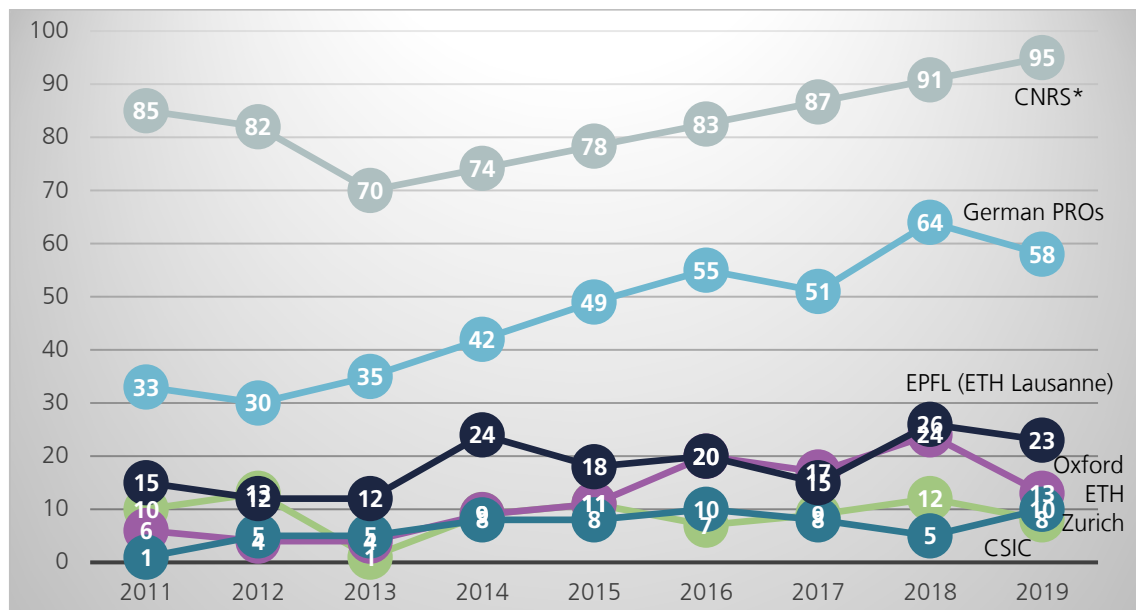

* Absolute numbers for CNRS are partly interpolated and are estimated based on incomplete time series and general information in annual reports.

Source: GWK, different annual reports (see methodology section); Fraunhofer ISI calculations.

The following analyses focus on the period 2017-2019 (see Figure 4). In absolute terms, UCS and CNRS are at the top with 287 and 273 spin-offs in the three-year period, respectively. The German PROs are ranking third with Fraunhofer contributing with 81, Helmholtz with 61, Max-Planck with 18 and Leibniz with 13 IP- or license-based spin-offs in the observation period. The US-American universities in Texas, the MIT and Stanford are in the upper part of the list. EPFL and University of Oxford have the highest output of spin-offs among European universities.

Figure 4: Absolute number of spin-offs for a selected set of national and international organisations, 2017-2019

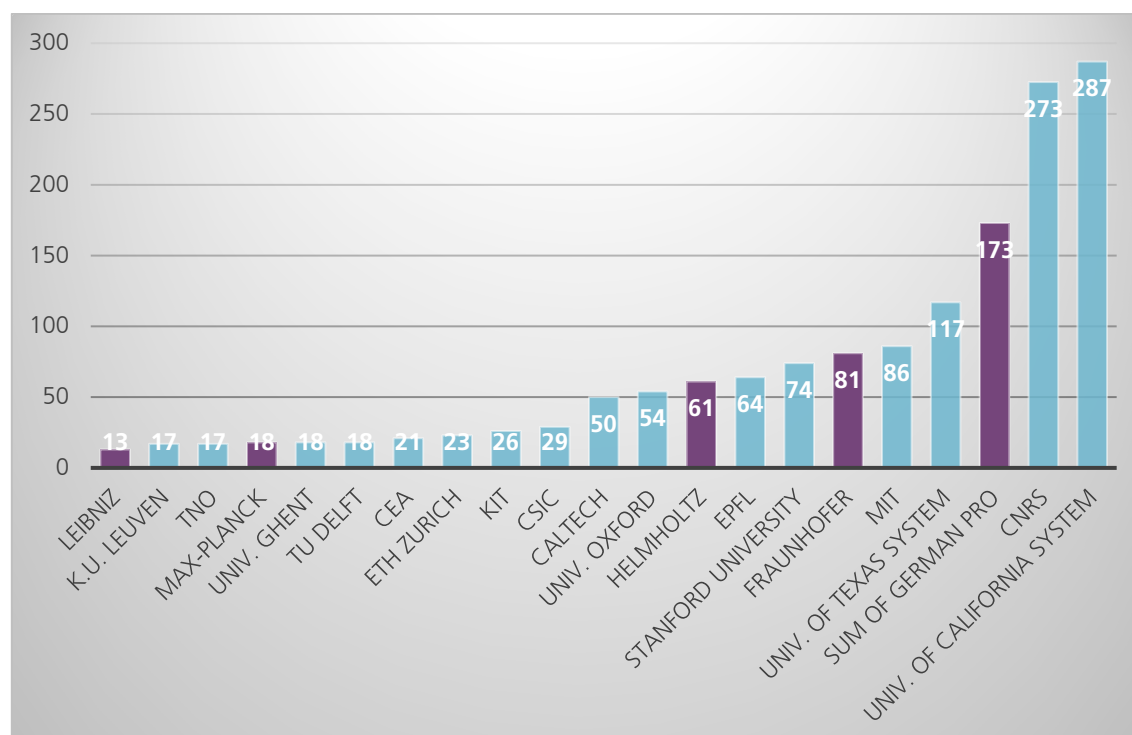

Source: GWK, AUTM, different annual reports (see methodology section); Fraunhofer ISI calculations.

As absolute numbers are - of course - massively influenced by size effects, a standardisation by the numbers of employees¹⁶ allows for a balanced comparison (see Figure 5). According to this, CalTech as well as EPFL are the most productive organisations under examination here, with 5.3 and 3.8 spin-offs per 1,000 employees in the three-year period 2017-2019, respectively. MIT and TNO reach a level of 2.2 or 1.9 spin-offs, respectively. And then a large number of medium-level organisations with 1.5 down to 0.9 spin-offs per 1,000 employees exists, led by Stanford and Fraunhofer and with KIT and CSIC at the lower end of this midfield. Even ETH Zurich and University of Ghent are still close, while Helmholtz, K.U. Leuven, Max-Planck, the French CEA as well as Leibniz are at the lower end of this distribution.

¹⁶ A standardisation by the number of researchers might be more appropriate, but these numbers are not available for all organisations and/or are not comparable due to varying definitions of research staff. Analyses for some of the organisations showed, however, based on available and comparable data, that the relations between the organisations are rather stable. For the sake of the inclusion of a larger number of organisations in this comparison, the employees instead of the research staff statistics have been taken into account for standardising spin-off numbers.

Figure 5: Average number of spin-offs per 1,000 employees for a selected set of national and international organisations, 2017-2019

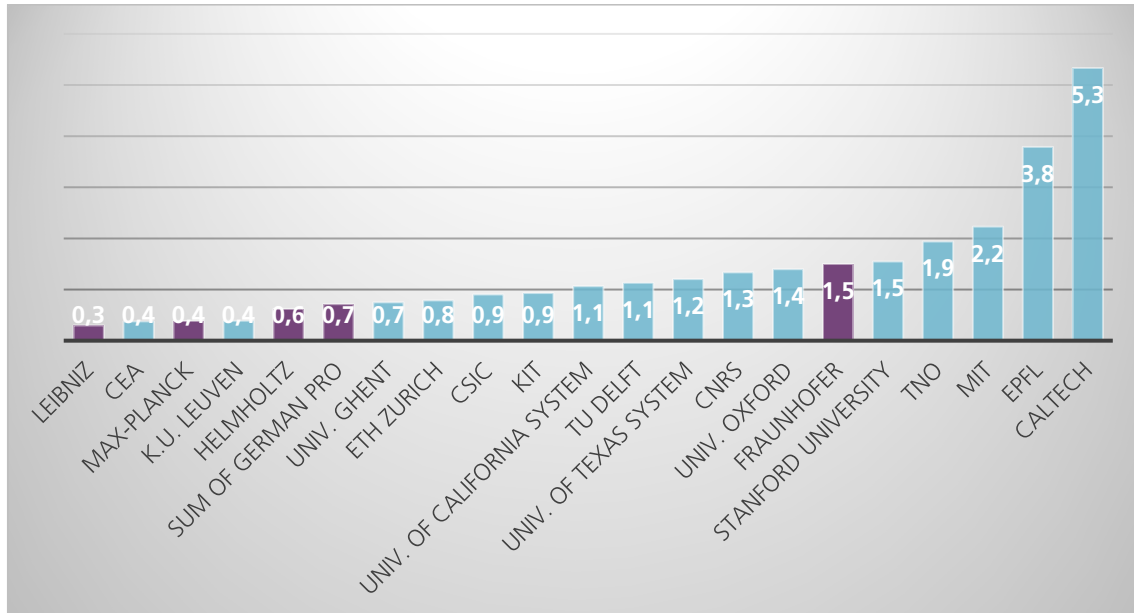

Source: GWK, destatis, AUTM, IPEDS, different annual reports (see methodology section), ETER; Fraunhofer ISI calculations.

When interpreting these numbers, structural differences still need to be taken into account, although we have applied the same definitions of spin-offs. This definition of IP- and license-based spin-offs as it is applied here demands IPR as a pre-requisite. For example, the missions of Leibniz and Max-Planck are not applied research, but basic research as well as documentation and therefore they neither have a large propensity to patent nor, consequently, to spin-off IP- or license-based companies. Most countries had introduced a Bayh-Dohle-Act-like regulation in the past two decades (Geuna et al. 2006; Lissoni et al 2008; Crespi et al. 2011; Dornbusch and Neuhäusler 2015) that puts universities or research organisations in the ownership of an invention made by their employees. For example, in Germany the so-called professor's privilege has been abolished in 2002. In consequence, the numbers of patent applications by individuals have been decreasing and the numbers of filings by the universities have been increasing since (Neuhäusler et al. 2019). However, some countries do not have such a regulation and organisations might therefore have a lower propensity to spin-off IP-based companies. It needs to be stressed, however, that this is a rare regulation and does not at all occur in any of the countries in our sample examined here.

Another important difference that influences the propensity to spin-out IP-based companies is national patent law. While in Europe (including the European Patent Office

EPO and its member and associated countries) patent protection of software as such (software-patents) is not provided by the patent system. In the opposite, it is possible to file software-patents at the United States Patent and Trademark Office (Blind et al. 2005; Graham and Mowery 2005; Bessen and Hunt 2007; Hall and MacGarvie 2010). In Europe, only embedded software can be patented or more generally: computer-implemented inventions, which refers to inventions that solve technical problems with technical means. Although it is estimated that meanwhile around 1/3 of all patents at the EPO are computer-implemented inventions (Frietsch et al. 2015; Frietsch et al. 2016), a difference especially to the USA is evident that might influence the possibilities of research organisations to file patents in this area and to found IP-based spin-offs, in consequence.

Furthermore, the disciplinary or technological profiles of the organisations play an important role in defining their propensity to spin-off companies. A micro-analysis of the individual spin-offs by organisations in our sample is beyond the scope and the resources of this study. Inspections of the lists of names of spin-offs showed large shares in the medical and pharmaceutical context. Organisations with strong profiles in medical research, pharmaceuticals or biotechnology might have more opportunities to create start-up companies based on their patented research than, for example, organisations with mechanical engineering or process industry technologies.

In sum, given all the restrictions of the analyses as well as the interpretability of the data we presented in this section, two main messages can be derived. First, German PROs - similar to most organisations under examination here - have been able to increase their output of IP- or license-based spin-offs in the past years, proving both, more sensitivity and more opportunities to create such start-ups. Second, German PROs are - given their missions and their profiles - at a comparable level with prominent organisations worldwide, which does not demand for severe action at first sight. However, aiming for improvements is always a good aspiration. The reduction of strategic, administrative and cultural obstacles is what is in the organisations hands and the provision of optimal framework conditions is in the realm of policy makers, once society accedes to spin-offs as a reasonable output to be strived for by research organisations.

It should also be kept in mind that spin-off creation is only one out of several ways to transfer scientific knowledge to industry, to commercialise it or to create new jobs based on it. Only the integrated assessment of a bundle of transfer mechanisms allows for a broader picture. In consequence, one should be cautious in jumping to conclusions of low spin-off productivity in Germany or high spin-off productivity in the USA, for example.

4 Interviews with spin-off active research organisations

4.1 Introduction

Benchmark analysis was conducted in order to analyse best practices and framework conditions for spin-off creation. To this end, a series of interviews was conducted with representatives of technology transfer organisations in a selection of relevant universities and non-university public research organisations in Europe and North America.

This chapter is structured as follows. We first explain the methodological approach. Then we talk about how participating organisations frame the rationale for spin-off support and how these rationales connect to their broader goals and missions. We then review the key challenges of academic spin-offs and the strategies used to address them. We conclude with the outline of the specific advantages of supporting spin-offs in universities and in non-university public research organisations.

4.2 Interviewee selection

Target organisations were selected according to two principles. First, we analysed available academic literature on university-industry knowledge transfer that provided insights into the national differences in terms of spin-off support and identified research organisations of interest. Second, we used the results of the international comparative analysis of spin-offs conducted in Chapter 3 to select organisations that were among the leaders in terms of the number of start-ups created and the organisations that increased the number of spin-offs in the recent years. As the result, 22 organisations were selected for the benchmarking study.

The interviews targeted technology transfer office (TTO) representatives or persons who were responsible for commercialisation of research. TTOs are not only aware of the advantages, challenges and the overall environment of spin-offs from their organisations, but also have significant influence on the technology transfer process (Nosella and Grimaldi, 2009). In three of the selected organisations, technology transfer was decentralised and distributed across the institutes and departments, while the other 19 organisations had a TTO. We excluded the three organisations without the dedicated central TTO from the list of target interviewees.

Interviews were conducted with representatives of 14 research organisations. 3 of these are US Universities, 3 are UK Universities, and 8 interviews were conducted with

organisations in the EU: 4 with universities and 4 with non-university public research organisations. All of them are comprehensive universities and research organisations that perform research in a wide range of scientific fields.

4.3 Method and Data

The interviews lasted between 30 and 45 minutes and followed a semi-structured methodology. The following topics were discussed in all interviews:

- Definition of a spin-off, key performance indicators (KPIs) and strategic management approach to spin-off support in the target organisation
- Advantages and challenges for spin-offs in the target organisation
- Framework conditions and the institutional environment (organisational, regional, national).

Additionally, non-university research organisations were asked about the distinctive advantages and disadvantages of spin-offs from non-university organisations compared to universities. Extra questions were asked depending on the nature of the organisation and the issues raised during the interview. The interviewees were encouraged to mention best practices and examples that could be particularly helpful in learning about how to better support spin-off creation.

The interview notes were written up and thematic analysis was performed in Nvivo 12. The themes raised in the interviews were analysed in the context of the available secondary data and previous research in order to triangulate the interviewees' assessments and gain a deeper insight into the circumstances of the research organisations included in the analysis.

4.4 Rationale and strategic approaches to spin-off support

In the majority of the participating organisations companies are recognised as spin-offs if they have a formal relationship with the parent organisation. IP licensing is the standard approach to assign companies as spin-offs, usually the parent organisation would take equity share in the company. Some participating organisations also have conditions for spin-off founders to be current or former staff at the research organisation. This criterion was used sometimes as the alternative to the IP licensing model and sometimes as the requirement in addition to it. In the majority of cases, a strict distinction was made between companies established by staff and students.

Participating organisations typically do not monitor knowledge-based spin-off companies as this is a resource-consuming effort and the TTO is not involved in their creation and growth. When such companies are monitored, it is for the purposes of building the public image rather than strategic management.

Although the way spin-offs are defined is fairly consistent across the participating organisations, the way in which the purpose of spin-off creation is understood and, as a consequence, the type of support the TTO provides and how its performance is assessed varies significantly. We identified three strategic orientation vectors regarding spin-off support:

- orientation towards survival versus learning
- orientation towards internal versus external processes
- orientation towards streamlining versus diversity of missions

The first vector, the *orientation towards survival versus learning*, was the most divisive topic in the interviews. The core question is whether the TTO should spin-out as many companies as possible regardless of their likelihood of survival, or whether the TTO should prioritise the support of spin-offs with the highest chances to develop into 'proper' businesses. Survival orientation means that the TTO institutes strict criteria for the projects it supports, sometimes it implements screening and filtering, it may discontinue the support of spin-offs that it perceives as less competitive. By the virtue of such screening, the TTO is able to dedicate significant resources to a select number of high potential spin-offs, providing substantial, more personalised support over a longer period of time.

In contrast, TTOs with learning orientation have more relaxed conditions for support and may even spin-out companies with low chances of survival, because their goal is to allow staff to learn from both successes and failures, build entrepreneurial capabilities in their organisations and nurture an entrepreneurial climate. Such TTOs typically have structures in place that would enable the researchers to 'trial' entrepreneurship, but retain a path back into science.

In terms of the KPIs, TTOs with survival orientation tend to monitor metrics, such as investment raised by the spin-offs or spin-offs that become listed companies, while for the TTOs with a learning orientation the number of spin-offs is the key KPI. The purpose of spin-off support and the KPIs used to monitor its achievement are aligned with the broader societal of the research organisation. For example, universities that are central actors in their innovation ecosystems need to prioritise local impact and job creation, therefore they have more incentives to nurture spin-offs that grow into proper businesses.

The second vector, *orientation towards internal versus external processes*, refers to the extent to which the TTO steps outside of the organisational boundaries to influence the broader entrepreneurial environment. TTOs with internal orientation concentrate their efforts on supporting projects at pre-incorporation and early incorporation stages. TTOs with external orientation also see joint work with external actors to build an attractive entrepreneurial ecosystem as a part of their mission. These interviewees, especially from the organisations located outside of the major financial centres, were aware that their spin-offs would have fewer chances to survive unless the TTO helped nurture favourable external environment (see more in Section 3.5.3). Interviewees from organisations where such environment already existed were more focused on improving internal support mechanisms.

The third vector, *diversity*, refers to the relative importance of businesses with broader social and environmental missions and the breadth of support tools allocated to such companies by the TTO. All interviewees acknowledged the need for publicly funded research to address pressing societal and environmental challenges. Several also mentioned the relevant framework conditions, such as impact cases conducted as a part of research impact evaluations, which affected the TTO's resources and the way in which scientists interacted with it. Most participating organisations also implemented special provisions to accelerate the transfer of technologies that address the Covid-19 pandemic. The majority acknowledged that environmental and societal considerations will only play a bigger role in technology transfer in the future.

In practice, participating organisations institutionalised support for responsible and societally-relevant innovations to a different extent. A minority explicitly instruct that each spin-off proposal to consider the social relevance of their research, recruited social enterprise experts into the TTO and to sit on advisory panels. The majority implement certain 'green' funding instruments, which target these specific innovations. A minority of interviewees, while acknowledging the importance of societal missions, prioritise the setting up of technology clusters in their region and supporting conventional science-based innovative spin-offs.

4.5 Key challenges and strategies to overcome them

The interviewees identified a number of challenges that spin-offs typically face and explained their preferred strategies in overcoming them. We divide the challenges into four groups: challenges arising in pre-seed, seed, and scaling up phases of growth, as well as issues related to background regulation, institutions and culture. The topics

related to the key challenges and their relative coverage in the interviews are presented in Table 2.

Table 2: Coverage of the main challenges of spin-off support and strategies to address them in the interviews¹⁷

Challenges	References	Solutions	References
<i>Pre-seed phase</i>			
Team	10	Coaching and advice	8
Technology maturity	8	Entrepreneurship education	4
Market and business plan	2	External expertise	5
		Further R&D funding	3
		Differential approach to scientific fields	6
		Pre-seed funding instruments	11
<i>Seed phase</i>			
Seed capital and resources	5	Accelerators and incubators	5
		Seed funding instruments	16
		TTO as the guarantor	4
<i>Scaling-up phase</i>			
Scale-up capital	8	Ecosystem and clusters	13
		Foreign capital	5
		Partnering	4
<i>Regulation, institutions and culture</i>			
Lack of entrepreneurial culture	3	Researcher trust building	3
Regulatory and structural obstacles	4	Incentives for researchers	4
		Indirect and fiscal instruments	1
		Support of senior leadership	2

Source: Fraunhofer ISI

Pre-seed and seed funding instruments that are available at the TTO, at the research organisation generally, and on the regional, national and supranational (EU) level was the most frequently discussed theme in the interviews. This chapter does not discuss specific programmes. However, a common strategy among the participating organisations was to spot gaps in the funding landscape and mobilise internal resources to address them. The TTOs preferred to design problem-solving instruments rather than to duplicate instruments that are already available elsewhere. Several interviewees discussed potential merits of increasing opportunities by setting up e.g. multiple streams

¹⁷ The references columns count the number of times a theme was coded. A theme could be coded more than once per interview.

of seed funding. However, they saw more value when their organisations introduced instruments that complemented the opportunities already present in the ecosystem.

4.5.1 Pre-seed phase

A strong theme in the interviews was that the eventual success of a spin-off is influenced by a number of factors before the company is formed. The team, the technology maturity and the market are the key interconnected cornerstones of a strong spin-offs. Each element has its own challenges, but the TTOs also dedicate significant resources to improve the fit between the three.

With respect to the spin-off team, the need to ensure that the spin-off team has the right combination of skills, competences, and passion was consistently mentioned as a major challenge by the interviewees. They commented that scientists are rarely able to seamlessly transition into being entrepreneurs. Entrepreneurial training and education, including formal courses, can help researchers develop an entrepreneurial mindset.

Another instrument that facilitates the entrepreneurial skillset in a spin-off is bringing in external expertise. It can be mobilised in a variety of ways, ranging from recruiting an external CEO to seeking mentoring from entrepreneurs in residence. Overall, external expertise was consistently noted as the important mechanism to improve the team of an innovative spin-off. TTO staff, especially if they have entrepreneurial or investor background, can also fulfil this role. Experts can also help with other pre-seed challenges, such as business plan development.

Technology readiness - the need to put in additional work in order to move the technology from the lab to a market - is a well-known major challenge in research spin-offs. It is also one of the most straightforward issues to address: the interviewees pointed out the value of funding opportunities (both internal and external to their research organisations) to conduct further R&D, proof of concept and feasibility studies¹⁸. Addressing the differential needs of the different research fields was also discussed: for example, prototype manufacturing in the physical sciences or drug design and discovery in life sciences.

¹⁸ Due to conflict of interest policies in the majority of participating organisations spin-offs do not have preferential access to research facilities in their parent organisations. Academic founders must strictly separate their research work from their work in a company. Therefore, the interviewees spoke about pre-seed R&D support tools designed specifically for spin-offs.

4.5.2 Seed phase

In the seed phase, the main challenge of a new company is to secure initial investment and survive 'the valley of death' while establishing itself as a competitive player on the market. The majority of the interviewees did not recognise the survival of the seed phase as an issue that requires further attention. On the contrary, challenges of seed phase survival are well recognised by policymakers and have been addressed in a variety of research and innovation support programmes. Issues arising when spin-offs struggle to secure seed investment were attributed by the interviewees largely to pre-seed factors, such as a niche technology or the lack of potential for growth; these make the spin-off less attractive to investors.

A bigger challenge is building investor confidence in a spin-off. According to one interviewee, in the seed phase most start-ups are "*starving*", but once they gain some recognition, "*people start throwing money at them*" (I12). The problem is therefore not the lack of investment per se, but getting the start-up to the point where its value proposition is acknowledged so that the snowball effect can follow. The main strategy to address this is for the TTO to engage with the investor community in order to increase the visibility of their spin-offs. Some participating organisations developed a 'guarantor' strategy: focusing on the survival orientation, they only support a small number of very high potential companies that gain a 'seal of approval'. Such strategy raises investor confidence in these spin-offs.

4.5.3 Scaling-up phase

Not all interviewees considered the scaling-up phase as the phase where spin-offs still should be supported by their parent organisation. However, the lack of scale-up investment was noted as a serious issue by the interviewees from research organisations located outside of the major clusters and financial centres. Scale-up capital cannot be easily provided via public programmes or organised from within the research organisations. Its sources are venture capital, angel investors and investment funds that congregate in major centres. Additionally, interviewees noted that fewer investors deal with science-based innovation, because research-intensive companies take relatively longer time to generate returns. Therefore, in locations outside of the major centres opportunities to secure scale-up investment are scarce.

The interviews offer multiple possible solutions for the issue of scale-up investment. In the short term, a TTO can seek to build links with investors in the major centres nationally and also abroad in order to bring in capital. However, such strategy may result in brain

drain: spin-offs may choose to relocate to clusters that offer more attractive opportunities, or be acquired by multinational companies. This may result in the loss of talent and technology. This leads to particularly negative consequences for peripheral regions that rely on local research organisations to propel growth. Technology sovereignty - the need for the country to retain control over critical technologies - is also an increasing concern when it comes to foreign investment in science-based spin-offs.

The interviewees were instead in favour of the solutions that might require the investment of resources over a longer period of time, but would also provide a sustainable solution. These are building the local innovation ecosystem and partnering. Innovation ecosystem is a dynamic and interconnected hub that brings together people, culture and technology, triggers invention and accelerates innovation (Carayannis and Campbell, 2009). In order for the ecosystem to sustain itself over time, a certain saturation of actors and processes is needed, otherwise people and companies will leave to more attractive locations.

Nurturing an ecosystem, according to the interviewees, takes a long time. However, research organisations benefit greatly by being integrated in it. For example, VCs and large firms will come on their own to rich ecosystems, creating more opportunities. CEOs with business experience can be recruited for start-ups from the pool of talent. Spin-off proposals can be sent to experts for feedback to refine business ideas. Once in place, ecosystems create self-reinforcing positive feedback loops: the more processes take place, the more attractive the ecosystem is, the more talent and capital is brought in, the more processes and activities are initiated. Therefore, interviewees whose research organisations were already a part of a cluster or an ecosystem focused on improving internal processes and support, while interviewees whose organisations were not a part of an ecosystem sought to nurture their ecosystems in various ways.

An intermediate step that is less time and resource consuming than building an innovation ecosystem is a partnership strategy, especially if the research organisation is too remote, not large enough or if there are other reasons why an ecosystem is not a viable strategy. Several participating organisations offered examples of partnering with other universities, PROs and private actors - in their countries and internationally - in order to pool resources and set up solutions that would address the scale-up funding gap.

4.5.4 Regulation, Institutions and culture

A number of issues and related best practices refer to the broader framework conditions, institutional and cultural aspects of spin-off support. A major theme here in the interviews was the perception that Europe may still lag behind the US in terms of overall

entrepreneurial attitudes. European researchers still perceive entrepreneurship as a risky and unsteady career choice. When brought up, it was a perception shared by the European and US interviewees. European TTOs implemented relatively more measures that aim to spark researchers' interest towards commercialisation, build researchers' awareness about technology transfer, their confidence, skills, and develop an entrepreneurial mindset. Several interviewees named concrete incentives for academic inventors to seriously consider commercialisation of their results, for example, payments to inventors, opportunities to maintain dual employment as a researcher and a spin-off founder, a dedicated career track for technology transfer-oriented staff.

Interviewees expressed an overall positive outlook towards the evolution of spin-off support landscape in Europe. The efforts of national governments to emphasise the importance of universities' third mission stimulated research organisations to allocate more resources for technology transfer, leading to the increase of TTOs' budgets and influence. Various other best practices were mentioned, ranging from fiscal measures to accelerator programmes. Among the negatives, red tape and outdated regulation were mentioned as persistent, wicked problems. However, interviewees were convinced that an organisation can do a lot to address institutional and regulatory challenges. Trust and a close cooperation with the leadership team was noted as the critical condition to achieve this.

4.6 Spin-offs from universities and public research organisations

In conclusion, we report on the institutional differences between universities and non-university research organisations that influence their spin-off support portfolios. Innovative research spin-offs often have diverse needs when it comes to knowledge (e.g. multidisciplinary) and infrastructure. Both universities and research organisations accommodate these needs: universities offer the benefit of co-location public research organisations with institutes in multiple locations, offer access to these various locations, their communities and clusters.

Another advantage of public research organisations is that their headquarters are typically located in major centres where they have access to capital. TTOs are able to connect remote institutes with these networks so that spin-offs gain access to expertise, capital and markets. The drawback of such set-up is that researchers from these remote institutes may not be aware of or familiar with the TTO and the opportunities it provides. Therefore the TTO needs to develop a distributed, network approach and invest extra effort in building links with the researcher community.

The biggest advantage of universities is its student body. Students and staff benefit equally from entrepreneurial education and can learn from each other. Several interviewees from universities developed pre-seed strategies that mobilised the student entrepreneur resource, for example, to match student and staff entrepreneurs in order to build the right combination of competences in the spin-off team.

5 Identifying Spin-Offs from Public Research Organisations in Germany

5.1 Method

The main challenge for identifying spin-offs from PROs (and universities) through matching name of researchers and firm founders is the large number of homonyms (i.e. the same combination of first name(s) and surname represents different individuals). We employed two complementary approaches using the same basic data to tackle this challenge. One approach, developed and implemented by Fraunhofer ISI, puts strong emphasis on geographical and temporal proximity, i.e. the researcher location and the firm location must not be too distant and there must not be a too long time period between the scientific activity (publication or patenting) and founding of the firm. The second approach, developed and implemented by ZEW, puts more emphasis on similarities between the subject of the research activities (in terms of scientific discipline and field of technology) and the economic activity of the firm (in terms of industry) as well as on co-authors and co-inventors. While the Fraunhofer ISI approach applies a hierarchic algorithm (i.e. each firm is classified as being either a spin-off or not), the ZEW uses a probabilistic algorithm that generates a probability that a firm is a spin-off or not. As both approaches are largely complementary, a combination is likely to yield a more complete and accurate result than applying only one approach.

In what follows, we describe the basic data used in both approaches and the method applied in each approach.

5.1.1 *Basic Data*

The study rests on three main data sources:

- Bibliometric data: These include the names and affiliations of authors of scientific publications as well as characteristics of each publication (year, subject, co-authors)
- Patent data: These include the names and affiliations of inventors of patents as well as characteristics of each patent (filing year, field of technology, co-inventors)
- Company data: These include the names of firm founders as well as a few characteristics of the founders (e.g. age) and characteristics of the firm (industry, location, website address)

5.1.1.1 *Bibliometric data*

Bibliometric data was collected from the bibliometric database Scopus. Scopus provides information on articles published in more than 23,000 journals (serial titles) and more than 210,000 books as well as book chapters. It combines more than 77 million publication records from 1970 onwards, and it has about 16 million author profiles.¹⁹ It mainly covers journals in science, technology and medicine, but also social sciences and humanities – though the latter areas are not covered to the same extent (Michels and Schmoch 2012; Stahlschmidt et al. 2019). In recent years, the social sciences and humanities coverage has increased considerably, for example through extended book series coverage. While there is still a bias towards science, technology and medicine in terms of the number of publications covered, there is not necessarily such a bias in terms of authors.

Data on authors and their affiliations was directly extracted from Scopus. Scopus provides disambiguated author information based on inputs from the authors themselves (e.g. via ORCID or Researcher-ID) and employs an algorithm to disambiguate all authors that mainly uses database-inherent information like email addresses, affiliations, disciplinary background, but also co-authorship, for example. We assigned authors with multiple affiliations to each of the organisations that falls into the groups we are interested in, namely the four PROs and all German universities. This means that spin-offs that were founded by authors with more than one affiliation were also assigned to these multiple organisations. For example, a researcher publishes a paper while affiliated to Fraunhofer and at the same time to a German university, the foundation of that person is counted both for Fraunhofer and for the university.

For each author we calculated the scientific age (the number of years since the author's first publication) and geographic location (address of the author). In case of missing author address, we can use the (main) address of the affiliation that we extracted from other authors with the same affiliation. As Scopus mainly provides data from the mid-1990s onwards, with a broader coverage after 2005, we find a left-truncated distribution of age for authors with prior publications.

The data extraction led to a total of 1,264,294 different combinations of unique author names and affiliations for Germany in the period 2010-2019. Authors with multiple affiliations accordingly appear multiple times.

¹⁹ www.elsevier.com/_data/assets/pdf_file/0007/69451/Scopus_ContentCoverage_Guide_WEB.pdf

5.1.1.2 *Patent data*

Patent data were extracted from the 'EPO Worldwide Patent Statistical Database' (PATSTAT). The database covers information about published patents from 83 patent authorities worldwide, dating back to the late 19th century. It includes all information that are stated on a patent application, i.e. application authorities (patent offices), several patent relevant dates (priority, filing, publication date), inventor and applicant addresses, patent families (INPADOC and DOCDB), patent classifications (e.g. IPC and CPC), title and abstract of a patent filing, technical relations and continuations, citations to patents and to non-patent literature and information on legal events (PRS file).

The information needed for this study was extracted from patent applications at the German Patent and Trademark Office (DPMA) or the European Patent Office, where German research organisations and universities usually file their priority patents. Any subsequent filing like PCTs or direct filings at national offices outside Europe are not taken into account as priority filings are extremely rare. As there is no direct affiliation information for inventors, we considered all inventors of patents that were filed by German PROs or German universities as the applicant, assigning the inventor to the PRO or university that filed the patent. For identifying patent applications by German PROs or German universities, we used a complete list of all German PROs, including their individual institutes, or German universities that has been collected by Fraunhofer ISI.

The data extraction led to a total of 18,804 different combinations of patent-inventor-affiliation combinations. In terms of inventors, we use 11,904 distinct names for Germany for the period 2010-2018. Inventors with multiple affiliations appear multiple times and are assigned to each of the affiliated organisations.

5.1.1.3 *Company data*

We employed two publicly available company data bases, Hoppenstedt and Creditreform. The Hoppenstedt data base was used for the Fraunhofer ISI approach while the Creditreform data base was used for the ZEW approach.

The Hoppenstedt database contains a comprehensive set of information on companies located in Germany and their founders, including founding year, geographic location, and the founder's name and age. For this project, we used the proprietary Hoppenstedt database and extracted all firms that were founded in any of the years 2010 to 2019 and had an industry code in NACE divisions 5 to 39 (manufacturing, mining, utilities), 58 to 66 (information, communication and financial services), 69 to 75 (professional, technical

or scientific services) or 77, 78, 82, 95 (renting, employment services, other business services, repair). The data extraction led to a total of 1,633,024 different combinations of unique founder names and firms. Also in this case, persons having founded multiple companies in our observation period appear multiple times, accordingly.

Creditreform data were used through the Mannheim Enterprise Panel (MUP, see Bersch et al. 2014). The MUP is a joint project of ZEW and Creditreform aiming at establishing a comprehensive panel data base of all firms in Germany from the year 2000 on, including firms that had ceased business in the meantime. The MUP focusses on firms with a minimum economic activity, excluding firms that only act as legal vehicles or were founded for non-economic purposes. Among others, the MUP contains data on all firm founders and managers. For this project, the entire MUP data base was used, including firms from all sectors and firms that were not active anymore at the time of analysis, hence covering a broader firm population than the Hoppenstedt data used in this project. However, firms not related to knowledge-based or innovation-oriented business areas were later excluded from the results.

5.1.2 Fraunhofer ISI Approach

The approach applied by Fraunhofer ISI to identify spin-offs combines advanced data processing tools and techniques by analysing the connection of a firm founder to PROs and universities via publications and patents. Such links are identified through a name-matching process, comparing the founder names with author and inventor names, along with an algorithmic selection encompassing several criteria explained in detail in Section 5.1.2.2. In sum, the method aims to identify spin-offs through the scientific work of its founders. The scope is limited to companies founded between 2010 and 2019 in Germany in sectors that are more closely related to knowledge-based activities.

The process follows a typical data analytics flow, including data collection, data treatment, data processing, and data analysis, as shown in Figure 6. It starts with data collection, gathering data from three sources: founders, authors, and inventors. Once the data is available, the pre-processing takes part, with the data cleaning and treatment necessary for the next steps, in a process also known as ETL (extract, transform, load), described in Section 5.1.2.1. With the datasets ready, the processing phase can then be executed. It is split into three steps: integration, name-matching, and algorithmic selection. First, the three datasets are integrated, and then a name-matching is performed to identify the correspondences. Given the high number of homonyms, what follows is an automatic selection based on several criteria, like geographic distance, age, and others explained in detail in Section 5.1.2.3. Next, there is a curation of data that

aims at excluding false positives, hereby called the post-processing phase. Finally, the data analysis comes with a validation using a control group of already known Fraunhofer spin-offs and the presentation of general statistics. The analytical process is iterative, and the outcomes retrofit the algorithmic selection and post-processing filtering.

Figure 6: Data analytics process of the Fraunhofer ISI approach

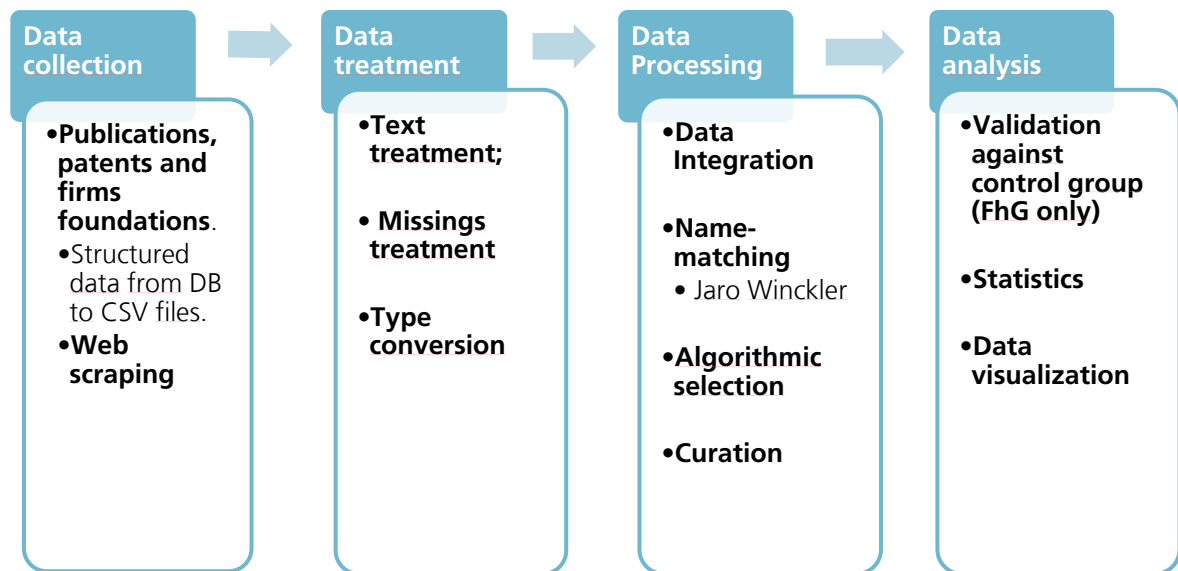

Source: Fraunhofer ISI

5.1.2.1 Data treatment and integration

As the data sources are structured, i.e., coming from the databases, the pre-processing was focused on data cleaning, normalisation, and formatting. The first procedure was to normalise the data, primarily the person names, encoding with the same pattern, namely UTF-8, and treating the names' accentuation, case, and order. For accentuation, special attention was given to umlauts, rather common in the German language. Regarding the name format, it was used LAST_NAME, FIRST_NAME standard. The middle names were kept in a separate field for potentials verifications, but not used for the matching procedure described in the next section.

The data treatment procedures can be summarised as follows:

- Umlauts treatment: Replacement of ö, ü, ä for oe, ue, ae, respectively.
- Special characters treatment: Replacement or removal. Ex: ß replace by ss.
- Personal names normalization: Setting names to uppercase and formatting them in the LAST_NAME, FIRST_NAME standard format;

- Zipcode treatment: Removing of string characters and formatting in the five-digit standard.

The treated data was then integrated using dedicated scripts written in Python and using *pandas*²⁰, a data analytics library, and its rich list of features that allow faster processing than traditional methods.

The data sources were merged into a single data frame, creating a Cartesian product of all three data sources. With this unified data frame, the processing work was done via *lambda functions*²¹. This simplified method can be many folds faster than traditional nested iterations when applied to pandas data series (unidimensional data frame).

5.1.2.2 Data processing and name matching

This section describes the identification method, split into three steps: 1) name-matching, 2) algorithmic selection, and 3) post-processing. In the name-matching phase, the founder's and author's names are combined and verified, resulting in a dataset with exact correspondences only. Next, a selection using filtering conditions is applied, as explained below in this section. Lastly, the post-processing refines the results by applying additional removings.

The name similarity domain has well-known algorithms and approaches. In this project, it experimented with the following algorithms:

- Levenshtein distance: It measures the difference between two strings, resulting in the number of changes necessary to equalize them.
- Jaro Winckler: It provides an index of similarity between two strings, ranging from 0 to 1. It is based on the Jaro distance metric, emphasizing the beginning of the string, rating higher the ones with greater similarity in the first characters. For that reason it is considered more efficient to match personal names.

However, given the data volume, the number of false positives, i.e., the mistaken matchings between authors and founders, remained excessively high even with a high similarity index– or low distance. For that reason, it was considered only exact matchings for the combination of first name and last name in the previously mentioned format (LAST_NAME, FIRST_NAME). That led to a reduction of the volume of false positives, limiting the name-matching mistakes to homonyms. This problem and other filterings are then applied through an algorithmic selection explained in the following section.

²⁰ <https://pandas.pydata.org/>

²¹ A lambda function is a small anonymous function that can take any number of arguments, but can only have one expression.

For multiple firm's foundations, it is evaluated how frequently the founder appears in the dataset. The reason is to avoid founders with numerous companies that are not necessarily entrepreneurs, or at least not with the usual track record of spin-off founders. For example, it is relatively common for founders to have multiple companies over the years (serial founders) or even simultaneously as an investor, which could create noise in our findings. Another case is assets management companies, for which one person is usually is the founder of numerous companies. To minimize this problem, the companies founded by persons with more than two companies, regardless of the sector, are not considered spin-offs and removed from the resulting dataset.

5.1.2.3 *Algorithmic selection*

The homonyms pose a great challenge in any name-matching exercise. In our case, the resulting name-matching dataset was submitted to an automatic selection, hereby called algorithmic selection, to funnel the matching results, filtering out the unlikely matchings, and therefore, keeping only the promising ones.

The method is split into two rounds. The aim is to get the most likely ones in the first round, while the remaining ones go through a more complex selection.

In the first round, depicted in Figure 7, three conditions are necessary to flag the matchings as high probable: geographic distance, co-founders with the same affiliation, and patent application.

The geographic distance observed is a range of 100 kilometres, i.e., the companies distance to the author's must be less than 100 km. For the companies we employed the current company address as well as its registration place. For the author it is the affiliation address of the PRO or university. This approach solves the problem of missing data, mainly on the author's side, and addresses the cases when the companies change their location over the years. The distance is calculated in all possible combinations, and the shortest one is selected. To calculate the distance is utilized the python library *pgeocode*²².

The multiple co-founders' criteria examine the affiliations of the co-founders. If more than one founder has the same affiliation, i.e., has published under the same PRO or university, there is a good chance they have been colleagues before founding the company under analysis. Considering that this verification is done after the name-matching, i.e. the names are the same which gives us a strong indication they are the same persons, spin-off founders.

²² <https://pypi.org/project/pgeocode/>

The third condition is the patent application. This criterion is examined parallel to the previous one (multiple co-founders) and determines a higher confidence in the match. The condition is that at least one of the co-founders has filed a patent. Additionally, it is verified if the organization presented in the patent register is the same as the affiliation. As the data sources are different, this verification is made through name-matching, in this case using the *Jaro Winkler* method, with a threshold of 0.8, i.e., both names have similarities higher than 80%. The implementation of Jaro Winckler use is the python library *Jellyfish*²³

To summarize this round, when a listed company has multiple co-founders from the PRO/University or has one co-founder as an inventor, it is considered a spin-off, given the distance criteria mentioned above is met. The flow gram is shown in Figure 7.

Figure 7: First round selection

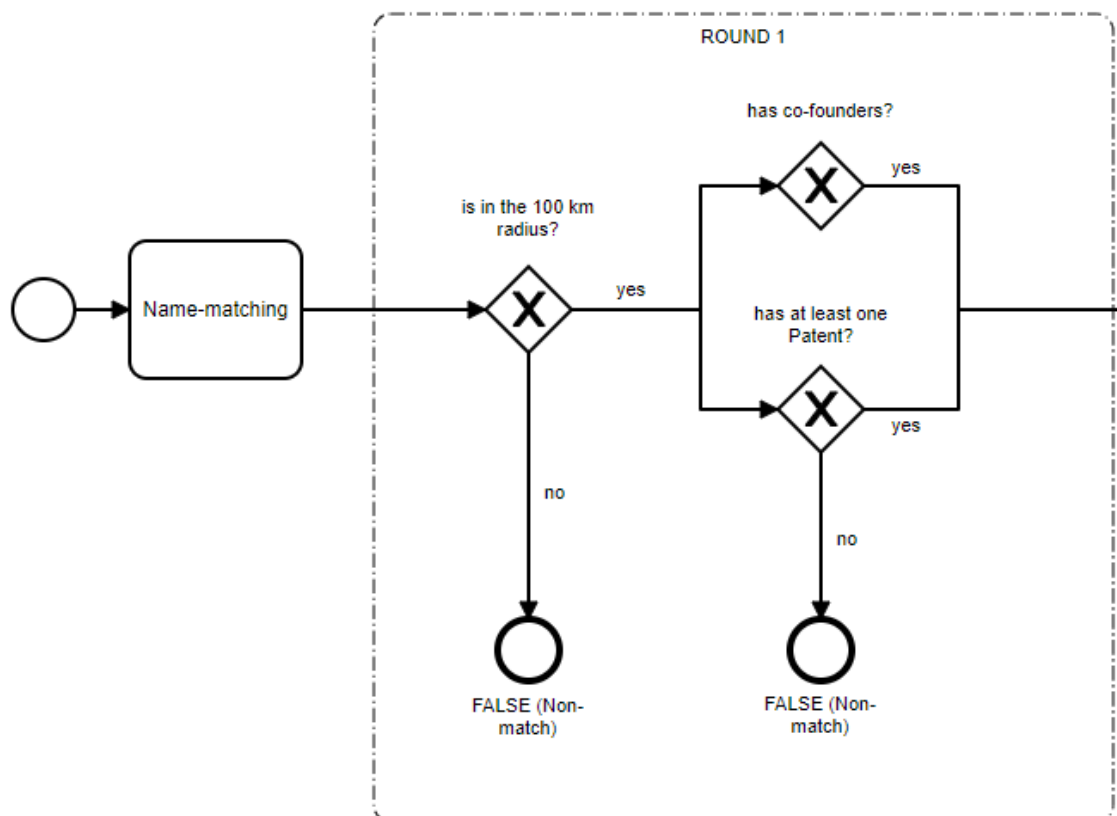

Source: Fraunhofer ISI

Those matchings which haven't met the first round conditions go through a second round, under a more detailed and complex investigation. Several other attributes were observed

²³ <https://pypi.org/project/jellyfish/>

in this phase, which could potentially connect founders, authors, and inventors, namely publication-foundation interval, age, name popularity, and geographic distance.

The publication-foundation interval is the time difference in years between the last author's publication and the company's foundation. The period must be less than seven years, e.g., if an author published in 2013 and founded a company in 2020, i.e., seven years later, the requirement is met. Such a difference aims to be flexible enough to capture the companies created right after a publication while excluding those founded by academics but not as a direct result of its research and therefore not linked to the PRO or University – a spin-off.

The age criteria verify the difference in years between the founder's age and the author's estimated age, which must be less than eight years, in both directions. The founder's information was available through the birth date in the data source (Hoppenstedt), but for the authors, it was necessary to create an estimation model, as follows:

$$\text{estimated_birth_date} = \text{pub_year} - \text{presumed_age} - \text{sci_year} \quad (1)$$

where *pub_year* is the author's last publication year (i.e. the most recent one), *presumed_age* is a constant value containing the presumed age of the author's first publication (set to twenty-seven years), and *sci_year* represents the number of years since the author's first publication.

For example, for an author with the last publication in 2020 and first in 2007 (scientific age of 14, considering current year), the estimated birth year is 1979. So, authors born between 1971 and 1987 are considered a match due to the bi-directional eight-years range.

This indicator allows selecting the matchings with approximate age and therefore removing the ones with a greater difference. Even with an arbitrary parameter, the presumed age of 27 for the first publication, the range gives enough flexibility to minimize undue true positives removal while filtering out homonyms of different generations.

Next, the name popularity determines how strict the geographic distance will be. The top-2000 name occurrences in the matchings were considered common names and prone to homonyms, justifying the narrowing in the geographic distance. The threshold was defined by observation, given the top-2000 presented more than 20 occurrences in the matching list.

Analogous to the first round, the geographic distance verifies how distant the company or the place of registration (*Handelsregister*) are to the author's affiliation address. The reason for the two alternative address information to be taken into account is that by observation of test data we found a number of cases, where the address of the firm was rather distant to the affiliation, but the registration - which often happens at a time when

the founder/author is still affiliated to the research organisation - takes place at a register court nearby the affiliation address. We therefore concluded that the geographic linkage, which is an essential information in our algorithm for the exclusion of false positives due to homonymes, might emerge from the location of the company, but also from the location of the registration court.

For the names marked as common names, the accepted distance is limited to 25 kilometres in a circle around the affiliation address. For non-common names we allowed a distance between company location and the location of the affiliation to be up to 100 kilometres. The flow gram that contains the above-explained conditions is shown in Figure 8.

Figure 8: Second round selection

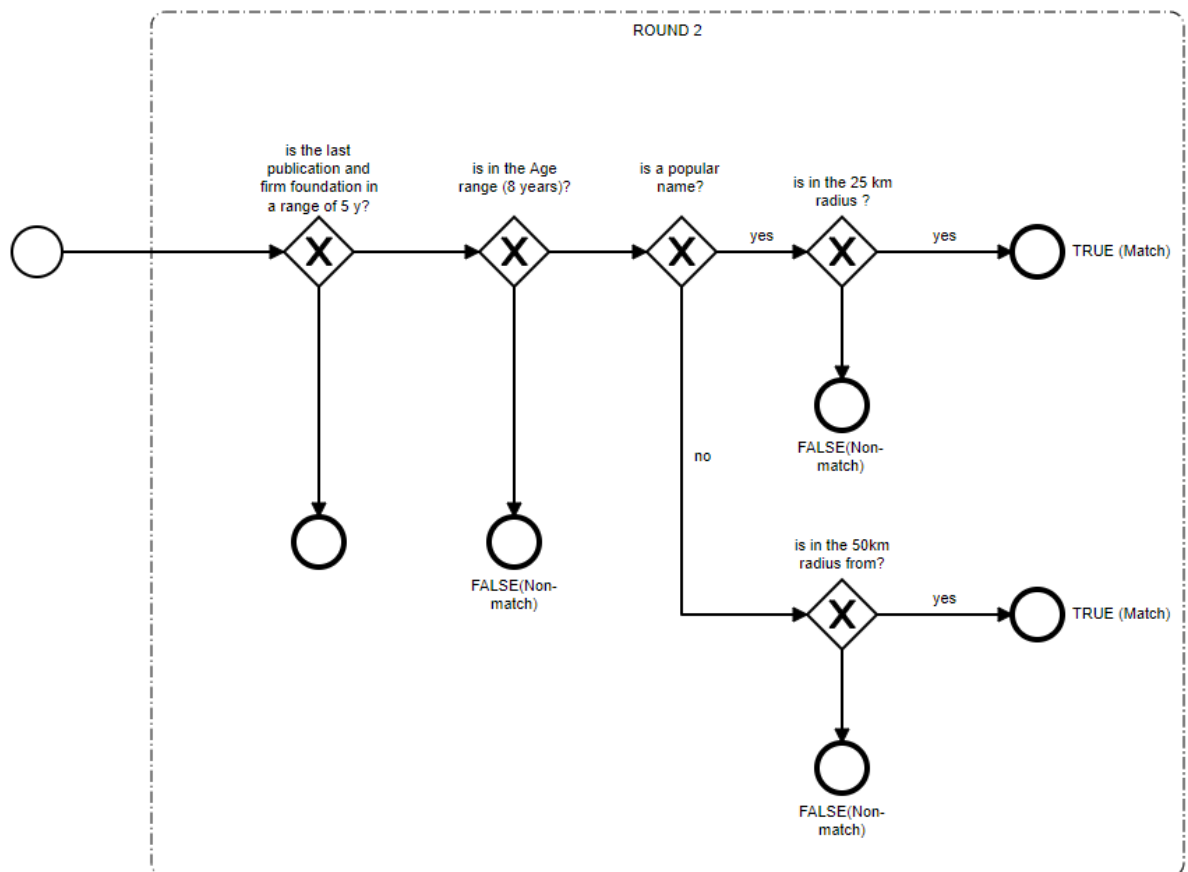

Source: Fraunhofer ISI

5.1.2.4 *Web scraping*

In order to increase the precision of the matching, a web scraping was performed as a complementary step. We collected information from the firm's website that could establish or indicate a link to research activities and possibly the PRO or university at which the author/inventor worked. Firms with no or no sufficient website information are not taken into account and stayed in the sample of matches. That is due mainly to the lack of the website's URL information. A substantial part of the identified firms have no website address information in our data source and could not be checked. The proportion of URLs available is approximately 60%.

The tool utilised was an in-house developed web scraper created to crawl and scrape companies' website content for previous projects at Fraunhofer ISI. This tool has its core functionalities available in an open-source repository²⁴ and is therefore publicly accessible.

The web scraping was executed for a total of 3,625 company website URLs. A total number of 1,218,591 individual pages have been successfully scraped. On 2,739 firm websites at least one research-related keyword was found. The results of this analysis enter into the next step of data processing, the quality control (see 5.1.4).

5.1.3 *ZEW Approach*

5.1.3.1 *Namesake risk assessment*

The ZEW approach to identify spin-offs employs a probabilistic method to determine whether a pair of author/inventor and firm founder with the same name is actually the identical person. A name is defined by the combination of first name(s) and second name. The method is called disambiguation by namesake risk assessment (see Doherr 2021 for details). The method determines the probability of drawing a namesake based on the number of namesakes in the population and the number of observed units. A Poisson model based on a master sample of unambiguously identified individuals estimates the main component, the number of namesakes for any given name. At the core of the implementation is a mechanism returning the unit size of the intersected mutual properties linking two individuals.

To illustrate the theory of namesakes, we use an example with one author and a large number of firm founders. With every new firm foundation, the risk for a namesake to the

²⁴ <https://github.com/dgltrtr/scrawler>

author increases. The extreme case is that every individual becoming a firm founder. As we are only interested in the risk of drawing any namesake, it is sufficient to handle the reverse case of drawing no namesake. The probability of drawing a valid founder (no namesake) equals the remaining number of individuals in the population that are no namesakes to the author, divided by the remaining population size. With every new founder, the numerator and the denominator of this relation decrease by one. Figure 9 illustrates the development of the probability of the author staying unique.

Figure 9: Probability tree for drawing a namesake vs. staying unique

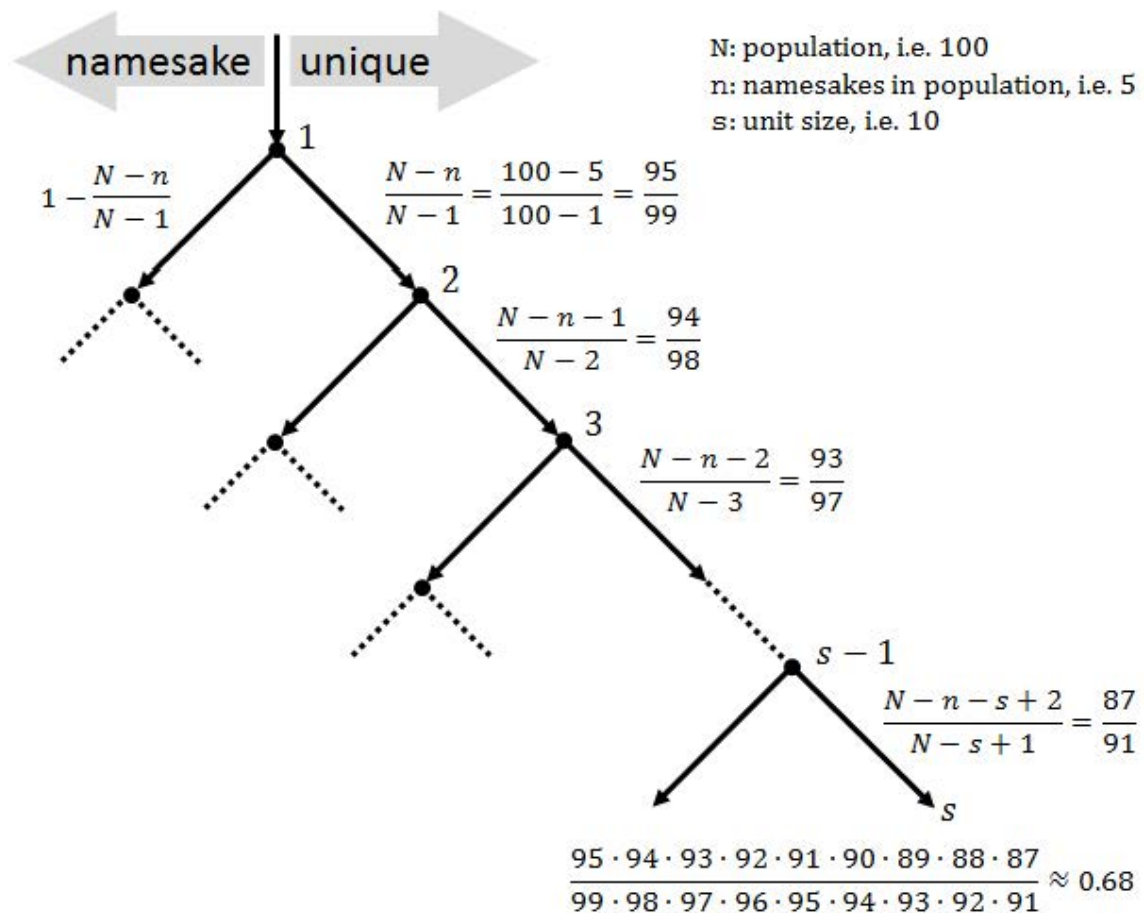

Source: Doherr (2021: 6)

In the example, the population N consists of 100 individuals (firm founders). The number of namesakes n in the population is 5, including the author. The final unit size s (number of firm founders) is 10. The probability of drawing a namesake with the first founder is $(1-95)/99 \approx 0.0404$. The probability of drawing a namesake to the author with the second founder is only slightly higher: $(1-94)/97 \approx 0.0408$. The parallel decrement of the numerator and the denominator has only a very small impact on the probabilities for

larger populations. The product of the probabilities of the unique branch is 68%, therefore is the likelihood for at least one other founder with the same name as the author 32%.

5.1.3.2 *Multivariate risk assessment*

To match authors/inventors and firm founders, the namesake risk assessment was combined with other variables that indicate that authors/inventors and firm founders with the same name may be one and the same person. For four variables, the following binary indicators were established:

- Co-authors, co-inventors and co-founders: Whenever a pair of author/inventor and founder have a co-author/co-inventor and a co-founder with the same name, the indicator was set to 1.
- Thematic agreement of firm activity and research activity: The firms' main industry code (NACE 5-digit) was aggregated to 35 industry groups. The authors were assigned to the same groups based on the disciplines of their articles (using the Scopus classification system). The inventors were assigned to the same groups based on their aggregated and weighted technology class portfolio derived from the truncated International Patent Classifications (IPC) of their patents. Whenever a pair of author/inventor and founder with the same name belong the same group, the indicator on thematic agreement was set to 1.
- Geographic proximity: Whenever the location of an author/inventor (address of the PRO/university) and a founder (address of the firm) were within a 25 km radius (based on the centre point of the ZIP code area), the indicator was set to 1. In addition, a second indicator for the 50 km radius was used. The indicator for a 50 km proximity was considered worse match than the 25 km proximity indicator.
- Temporal proximity: Whenever the year of firm foundation for a founder was not more than 3 years after the last publication/patent application of an author/inventor, the indicator was set to 1. In addition, a second indicator for a 6 year time span was used. The indicator for the 6 year time span was considered worse match than the indicator for the 3 year time span.

Based on the namesake risk assessment and the indicators on author/inventor and founder identity, a probability was calculated for each pair of author/inventor and firm founder with the same name. We only accepted linkages with a namesake risk below 5%. This risk was further mitigated by a consecutive background analysis based on plausibility checks to filter untypical founder behaviour like massive entrepreneurial activities and multiple founder assignments.

5.1.3.3 Web scraping

As a further indicator for identifying spin-offs, we analysed the firms' website with respect to references to the organisation (PRO or university) of the author/inventor. The analysis was performed for all firms that were considered a spin-off in the exercise described above, provided that the URL of the firm's website was available. Website addresses were taken from the MUP. We follow the scraping framework proposed by Kinne and Axenbeck (2021) and extract for each corporate website the 50 top-level webpages (webpages with the shortest URLs within the corporate website domain). Based on the text fragments extracted from these webpages, we first performed a 'broad matching' for any of the following search terms: fraunhofer, helmholtz, max-planck, leibniz, universität, hochschule, zentrum. Using regular expressions, we allow minor deviations of these search terms to still count as matches. In this way, we ensure that variations (e.g. max planck) and typos on websites are still captured by our procedure. The number of matches found through this approach is shown in Table 3.

Table 3: Results of a broad matching of firm websites mentioning PROs or universities

Search term	Total number of matches	Number of matched firms
fraunhofer	31,948	8,191
helmholtz	12,514	2,411
max-planck	27,963	5,449
leibniz	22,365	3,801
universität	401,056	84,068
hochschule	253,815	53,860
zentrum	1,119,666	167,342

Source: ZEW

If any of the above search terms matched, we extract a well-defined environment including the 100 preceding and 100 succeeding characters around the matched search term for a narrow matching. For this matching, we used the names and abbreviations of individual units of PROs (institutes, centres etc.) and individual universities as given as author/inventor affiliation in the bibliometric and patent databases (497 different affiliations) and used a flexible search algorithm to identify texts that contained the name of a PRO unit or university.

The result of the web scraping exercise was used to build an indicator for the co-occurrence of a reference to an affiliation on the firm's website and the same affiliation

of an author/inventor having the same name as one of the firm's founders. This indicator was used as another binary indicator in the multivariate risk assessment exercise as described above.

5.1.4 Quality Control

The results of the Fraunhofer ISI and the ZEW approach were merged into a single data base in order to execute quality controls. For this purpose, the spin-offs identified through the Fraunhofer ISI approach (based on information from the Hoppenstedt company register) were merged with the MUP (using data on the company's register number and VAT number as well as a matching based on name and address) in order to assign a unique company identifier to each firm. As part of this process, multiple entries of firms that represent the same economic unit have been removed (e.g. subsidiaries of a parent firm, holding or management companies, or legal forms that consist of more than one company, e.g. GmbH & Co. KG and KG).

The quality control consisted of two major steps: First, firms that were considered to be outside the target group of spin-offs in terms of their business activity or legal status were excluded. The procedure is described in section 5.1.4.1. Secondly, information on the firms' business activities was used to identify firms with an innovation-based business approach. For firms with no such business approach, further quality checks were made in order to identify failures.

5.1.4.1 Excluding firms outside the target group of spin-offs

The purpose of this study is to identify spin-offs from PROs (and universities) that contribute to the transfer of knowledge from public science to the business world. As discussed in section 2.3, not each firm foundation by a former researcher necessarily contributes to knowledge transfer. We used two criteria to identify (and potentially exclude) firms that are likely to be 'other spin-offs' as listed in Table 1:

- **Legal form:** Firms run by an individual, including freelancers and sole proprietorships (*Einzelunternehmen, Einzelfirma*), as well as firms with a legal form of an Association (*Verein*), co-operative (*Genossenschaft*) or a syndicate (*Arbeitsgemeinschaft*) were excluded.
- **Industry:** Firms from the following industries were excluded (using NACE codes): bakeries (1013*), butchers (1071*), other construction activities (43*), car trade/repair (45*), pharmacies (4773*), taxis (4932*), hotels (55*), restaurants (56*), banks (64*), insurances (65*), insurance agents (66229), real estate (68*),

legal and accounting activities (69*), holdings (701*), facility management (81*), health services (86*), care services (87*), social work (881*), child care (8891*), membership organisation (94*).

Firms that were classified under 'other activities' (NACE 74900, 82999, 96090) were excluded only in case of no indication for an innovation-based business activity was found (see the next section on the method used to identify innovation-based business activities). The reason for this choice is that in the company registers used in this study, many firms with an ambiguous business activity are assigned to one of these classes. While some of these firms are highly innovative and explore new ways of doing business (and are hence difficult to assign to one of the existing NACE classes), other firms do not disclose information about their actual economic activity and were hence assigned to one of these codes.

In addition, the company names were analysed (bases on a keyword list and through manual checking) in order to exclude further hits that are unlikely to be spin-offs. For this purpose, a list of terms were established that indicate a business activity outside the scope of this study and which have not been excluded based on the NACE code, e.g. wind power stations or farms.

5.1.4.2 *Focus on firms with innovation-driven business activities*

A second criterion of quality control refers to the link of the firms' business activities to innovation. Exchanging knowledge between PROs and the business sector requires some level of absorptive capacity at the side of the spin-off in order to effectively utilise the knowledge obtained from the PRO, and to interact with the PRO and other innovative firms. In order to establish whether a firm performs innovation-driven business activities, we conducted a semantic analysis of the description of the firm's business activities. For the Hoppenstedt database, a simple and rather general key word search was performed as a first step in order to identify firms with at least some (indirect) link to business activities related to innovation. Firms that did not show such a link were excluded.

For the combined data set, a more sophisticated search algorithm was applied that aims at identifying business activities related to R&D, computer programming and other software development activities as well as activities related to digitalisation. For this purpose, a semantic analysis using a ZEW software tool (Texan) was employed (see Krieger et al. 2020 for a description of the method).

The result of this exercise was used to exclude firms in case they showed an industry code outside of manufacturing and knowledge-based services (defining the latter very broadly by NACE codes 58 to 66 and 69 to 75).

5.2 Results

The method to identify spin-offs from the four large German PROs resulted in a total number of 1,925 founded during the ten years 2010 to 2019. The number of spin-offs from universities is 8,069 for the same time period. The combined number of spin-offs from PROs and universities is 9,001 (see Table 4). This figure is smaller than the sum of spin-offs from PROs and universities since some spin-offs are assigned to both sectors, either because an individual researcher has multiple affiliations or because the firm was founded by a team comprising both researchers from PROs and universities.

Table 4: Number of knowledge-based spin-offs from German PROs and universities 2010 to 2019 by identification approach

Identification approach	Number of spin-offs			Share (%)		
	PROs	Universities	Total*	PROs	Universities	Total*
Fraunhofer ISI and ZEW	526	1,931	2,111	27.3	23.9	23.5
Fraunhofer ISI only	469	2,955	3,424	24.4	36.6	38.0
ZEW only	930	3,183	3,466	48.3	39.4	38.5
Total	1,925	8,069	9,001	100.0	100.0	100.0

* Total is smaller than the sum of PROs and Universities since some spin-offs are assigned to both sectors (either because an individual researcher has multiple affiliations or because the firm was founded by a team comprising both researchers from PROs and universities).

Source: Fraunhofer ISI and ZEW

Only 23.5% of all spin-offs were found by both methods while 38.0% were found by the Fraunhofer ISI approach only, and 38.5% by the ZEW approach only. This result was expected as the two methods are complementary in nature and focus on different variables in order to avoid false positives, i.e. linking a firm founder to an author or inventor of the same name, although they are two different individuals. Interestingly, the ZEW approach found substantially more spin-offs from PROs than the Fraunhofer ISI approach. This may be explained by the fact that the ZEW approach does not require the spin-off to be founded in close geographic proximity to the incubator organisation. Obviously, a larger number of spin-offs from PROs were founded in quite some distance

to their incubator organisation. This seems less to be the case for spin-offs from universities.

When relating the number of spin-offs to the number of researchers for the time period 2010 to 2019, we find a share of 0.35% for PROs and 0.34% for universities.²⁵ This result suggests that the level of spin-off activities at both types of organisations is quite similar.

The number of spin-offs from each of the four PROs in Germany that were founded during 2010 and 2019 ranges from 316 for the Leibniz Gemeinschaft to 839 for the Helmholtz Gemeinschaft (Table 5). The Fraunhofer Gesellschaft (506) and the Max-Planck Gesellschaft (455) show a similar number of spin-offs. When related to the number of researchers at each organisation, the Max-Planck Gesellschaft shows the highest value (0.44%) and the Leibniz Gemeinschaft the lowest (0.31%). When interpreting the results, one should know that the Max-Planck Gesellschaft employees a particularly high share of researcher on temporary positions (usually PhD positions) whereas the share of permanent research staff is higher at the other PROs. A high share of non-permanent staff is likely to produce a larger number of spin-offs since researchers leaving the PRO will have to decide about their future career path, and founding a business might be one option.

Table 5: Number of knowledge-based spin-offs from German PROs 2010 to 2019 by PRO

	Spin-offs	Researchers*	Ratio (%)
Fraunhofer Gesellschaft	506	11,684	0.43
Helmholtz Gemeinschaft	839	23,340	0.36
Leibniz Gemeinschaft	316	10,083	0.31
Max-Planck Gesellschaft	455	10,273	0.44
4 large PROs**	1,925	55,381	0.35

* Number of scientific and technical personnel at full-time equivalents, annual average for the years 2010-2019

** Total for the 4 large PROs is smaller than the sum for the four PROs as some spin-offs are assigned to more than one PRO.

Source: Fraunhofer ISI and ZEW, Destatis.

²⁵ The figures are not perfectly comparable since for PROs we used the number of scientific and technical personnel at full-time equivalents while for universities we used the head count of scientific-cultural personnel with a main occupation at the university (i.e. excluding persons being employed at the university as a second occupation).

5.2.1 Trends

The number of spin-offs from German PROs increased during the 2010 decade, from about 180 per year from 2010 to 2013 to more than 200 per year since 2014 (Figure 10). For spin-offs from universities, the increase after 2013 was substantially stronger. The annual number of spin-offs rose from about 650 in 2013 to 960 in 2017. For 2019, our data show a decline in the number of spin-offs from both PROs and university, which is most likely due to an underreporting of newly founded firms in this year in the company registers used in this study.

Figure 10: Number of knowledge-based spin-offs from German PROs and universities 2010 to 2019

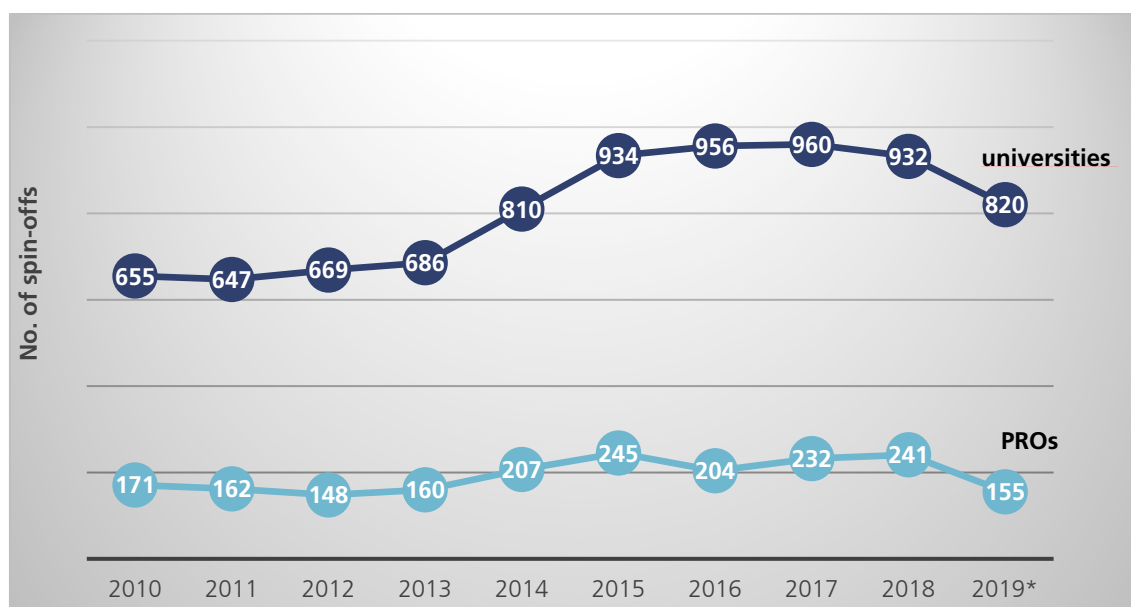

* Data for 2019 incomplete.

Source: Fraunhofer ISI and ZEW

The increase in spin-off activity from 2014 on was only partly driven by an increase in the number of researchers, resulting in an increase in the ratio of spin-offs per researcher. At PROs, this ratio was slightly higher than at universities for most years during 2010 and 2019 (Figure 11).

Figure 11: Ratio of knowledge-based spin-offs to researchers at German PROs and universities 2010 to 2019



* Data for 2019 incomplete.

Source: Fraunhofer ISI and ZEW

The increase in the number of spin-offs at German PROs after 2012/13 is evident for each of the four large PROs (Figure 12). It is most prominent for the Helmholtz Gemeinschaft and for the Fraunhofer Gesellschaft (with a higher number of spin-offs in 2015).

Figure 12: Number of knowledge-based spin-offs from German PROs 2010 to 2019 by PRO

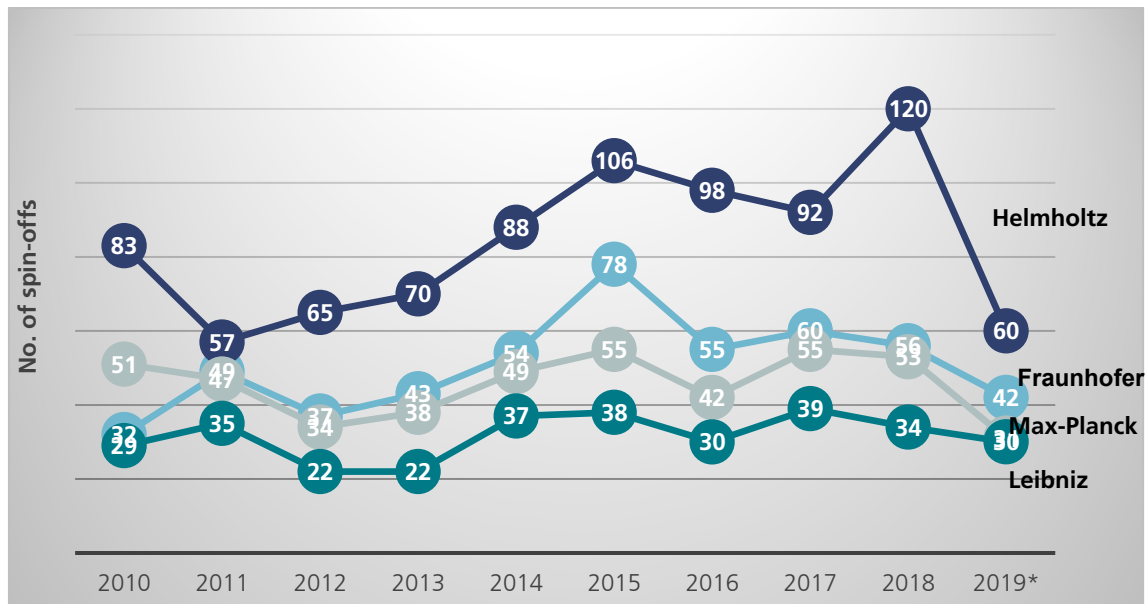

Source: Fraunhofer ISI and ZEW

The vast majority of spin-offs founded during 2010 and 2019 was still economically active by the end of 2020, although 2020 was a very difficult year owing to the government measures to combat the Covid-19 pandemic. The highest share of economically active spin-offs is found for spin-offs from the Fraunhofer Gesellschaft (82%) while the other three PROs report a share of 78% (Figure 13). Although the set of underlying spin-offs covered by this approach is different to officially reported numbers, this finding is consistent with former analyses by the Fraunhofer Gesellschaft, who reports that 97% of spin-offs still exist after 3 years, which is above the average of all high-tech start-ups monitored by the KfW-Gründungsmonitor. In addition, in terms of turnover and venture capital Fraunhofer spin-offs perform above average as well (see Pact for Research and Innovation IV, p. 6).²⁶

²⁶ <https://www.gwk-bonn.de/fileadmin/Redaktion/Dokumente/Papers/PFI-IV-2021-2030.pdf>

Figure 13: Status of economic activity of knowledge-based spin-offs from German PROs and universities founded during 2010 and 2019 by the end of 2020

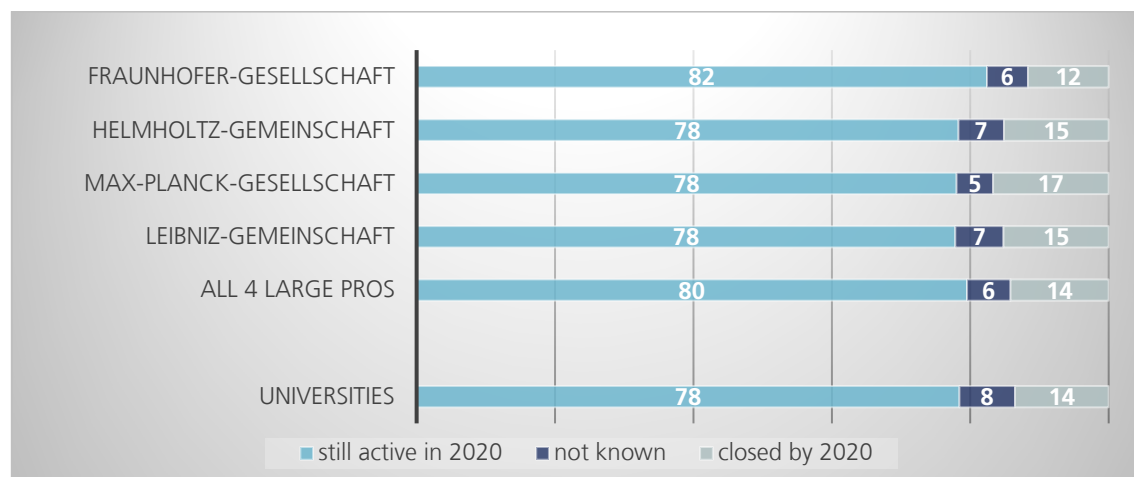

Source: Fraunhofer ISI and ZEW

5.2.2 Structural Characteristics of knowledge-based Spin-offs

5.2.2.1 Industries

The vast majority of spin-offs from PROs and universities offers services, including ICT services such as computer programming and software development, while only a small fraction is in the manufacturing business (Figure 14). Across all four large German PROs, the share of manufacturing spin-offs is 19%. 10% are assigned to industries that are characterised by high average R&D expenditure in relation to sales ('R&D intensive manufacturing') while 9% belong to other manufacturing. The share of manufacturing spin-offs is slightly higher for spin-offs from the Fraunhofer Gesellschaft (21%).

Almost 1 out of 3 spin-offs is offering ICT services. This share is highest for spin-offs from the the Fraunhofer Gesellschaft (36%) and lowest for spin-offs from the Leibniz Gemeinschaft (24%), reflecting differences in the disciplinary focus of research. 20% of all spin-offs from German PROs are offering other technical services such as engineering and architecture, R&D or technical testing and analysis. There are only small differences for this share across individual PROs. 18% of all spin-offs from PROs are active in other knowledge-intensive services such as consultancy, advertising, design and media. This share is rather low among spin-offs from the Fraunhofer Gesellschaft (14%). The same is true for the share of spin-offs in all other industries, which is 8% for the Fraunhofer

Gesellschaft, but 13% for all four large PROs, and 16% for spin-offs from the Max-Planck Gesellschaft and the Leibniz Gemeinschaft.

Figure 14: Industry distribution of knowledge-based spin-offs from German PROs and universities founded during 2010 and 2019

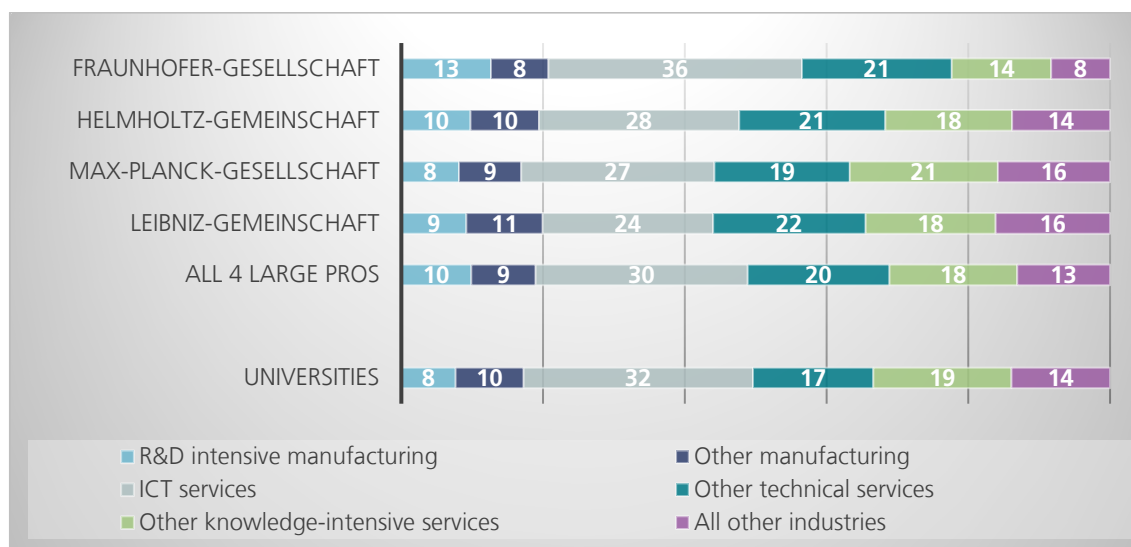

Source: Fraunhofer ISI and ZEW

5.2.2.2 Size

The size of spin-offs is measured by the number of employed persons, including founders that actively work in the firm. We use the maximum number of employed persons for each firm that was observed during the years 2010 to 2020. 38% of all spin-offs from PROs are run by a single person, 58% have not more than two persons engaged in the business, and more than two thirds of the spin-offs have not less than 5 employed persons. Only 6% of all PRO spin-offs grew to more than 30 employed persons, and less than 1% exceeded the number of 100 employed persons (Figure 15). Spin-offs from universities show almost the same size distribution as spin-offs from PROs. Among the four large PROs, spin-offs from the Fraunhofer Gesellschaft tend to be larger on average than spin-offs from the three other PROs.

Figure 15: Size of knowledge-based spin-offs from German PROs and universities founded during 2010 and 2019

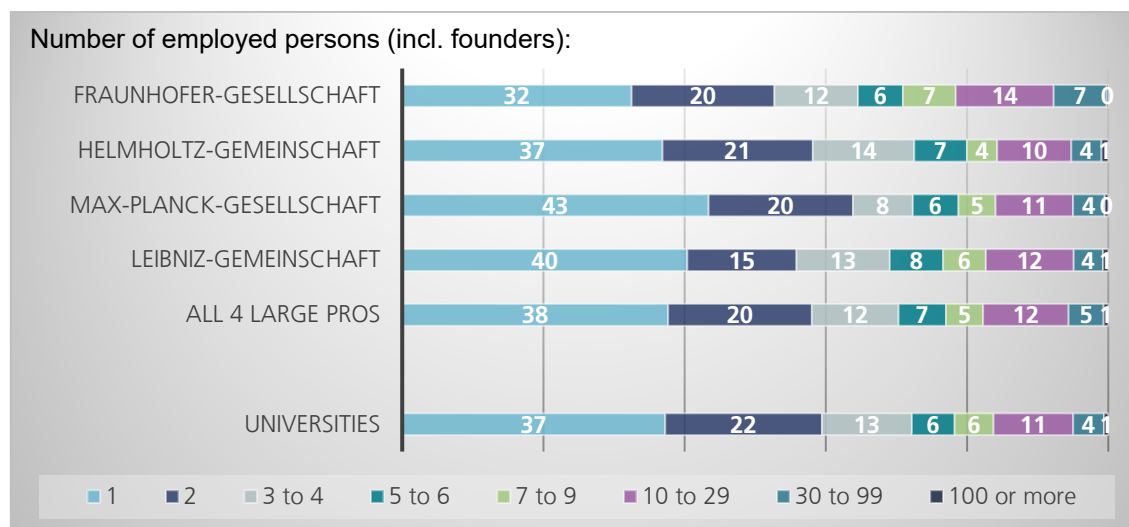

Number of employed persons refers to the year with the largest number (within the 2010-2020 period), excluding firms with no information on the number of employed persons (13% of all spin-offs).

Source: Fraunhofer ISI and ZEW

5.2.2.3 R&D activity

In order to establish whether spin-offs follow an R&D-based business approach, we examined the firms' description of their business activity with respect to content that indicates an R&D activity. We identified three types of R&D activity: research, experimental development, and software development (including data analytics and other sophisticated digitalisation activities). One should note that our measure of R&D activity is a rough indicator only since there may be firms that conduct R&D without mentioning it in the description of their business activity. At the same time, not all firms indicating R&D activities in their business activity description must necessarily be engaged in this activity.

Having these caveats in mind, we find that 10% of all PRO spin-offs conduct research and another 31% experimental development (but not research). A further 13% are engaged in software development and related digitalisation activities without stating research or experimental development activities (Figure 16). The share of firms with any R&D activity is highest among spin-offs from the Fraunhofer Gesellschaft and lowest for spin-offs from the Leibniz Gemeinschaft. Spin-offs from the Max-Planck Gesellschaft report the highest share of spin-offs with research activities (13%).

Figure 16: R&D activity of knowledge-based spin-offs from German PROs and universities founded during 2010 and 2019

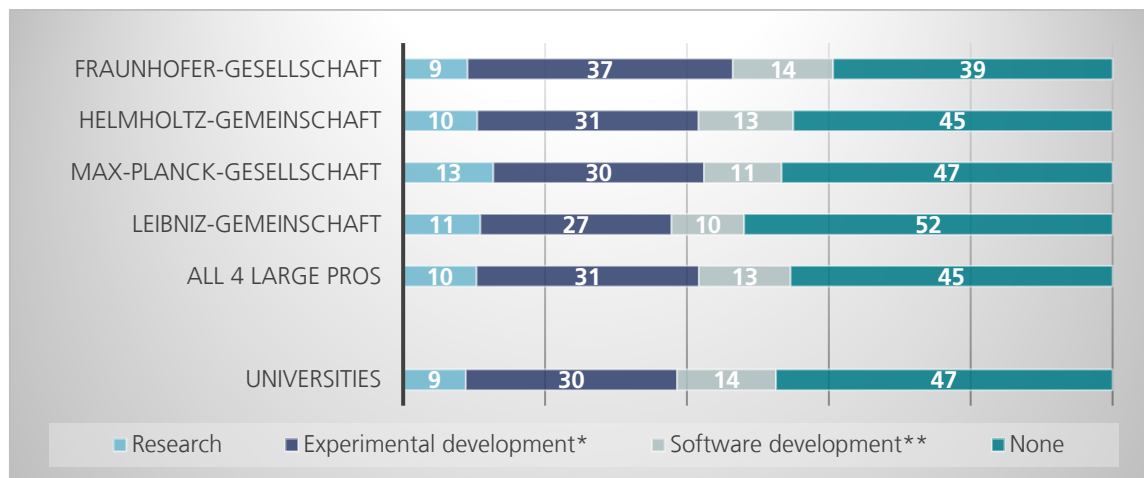

* but no research activity; ** but neither research nor experimental development activities; excluding firms with no information on their business activities (2% of all spin-offs).

Source: Fraunhofer ISI and ZEW

5.2.2.4 Regional distribution

The regional distribution of spin-offs from PROs shows some peculiarities when compared to the regional distribution of spin-offs from universities (Figure 17). 19.2% of all PRO spin-offs founded during 2010 to 2019 are located in Baden-Wuerttemberg, compared to 15.1% share for university spin-offs. Bavaria hosts 17.9% of all PRO spin-offs which is a significantly smaller share than for university spin-offs (20.9%). Berlin is the state with the third largest share in PRO spin-offs (14.4%), which is higher than the state's share in university spin-offs (11.9%). The largest German state, North-Rhine Westfalia, has a share of 12.9% in all PRO spin-offs, but 19.7% in all university spin-offs.

Figure 17: Distribution of knowledge-based spin-offs from German PROs and universities founded during 2010 and 2019 by German states

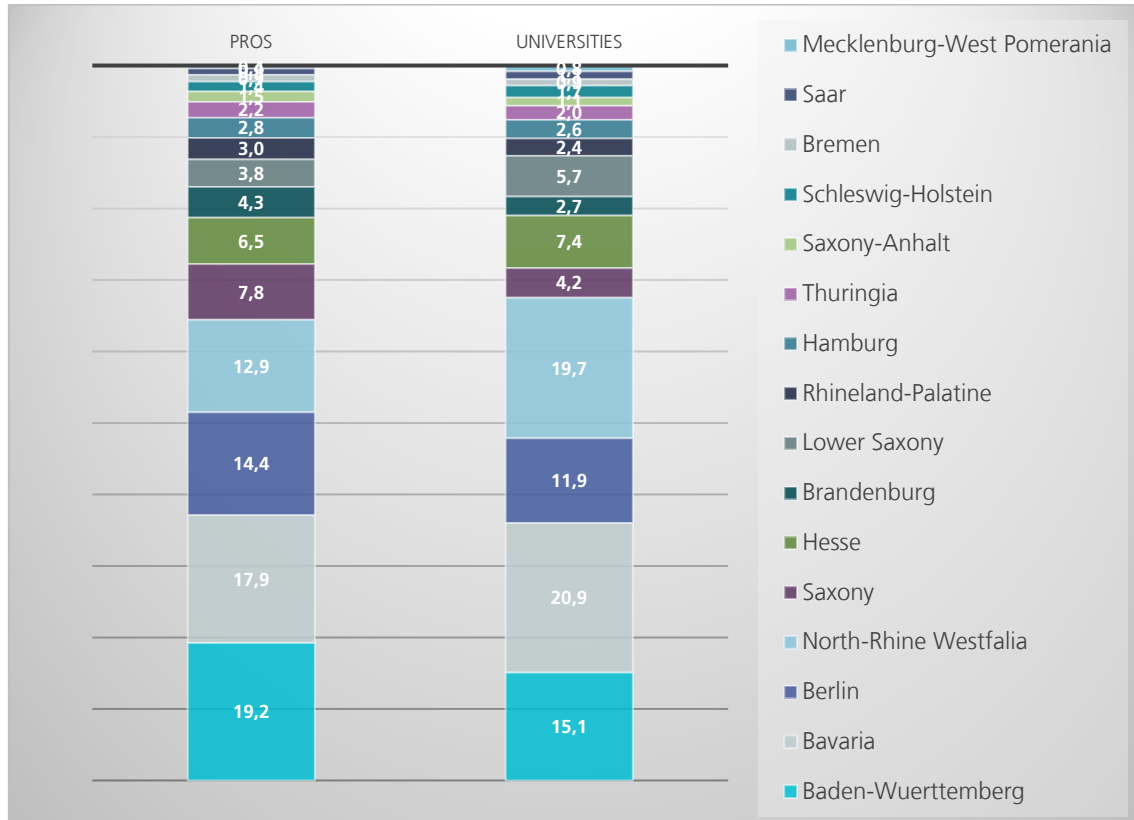

Source: Fraunhofer ISI and ZEW

In absolute figures, 370 PRO spin-offs were founded in Baden-Wuerttemberg during 2010 and 2019, 344 in Bavaria, 277 in Berlin and 249 in North-Rhine Westfalia. The high number of spin-offs in Baden-Wuerttemberg corresponds with the fact that this state hosts the largest number of researchers at one of the four large German PROs (close to 10,000, 2010-2019 average). However, North-Rhine Westfalia shows about the same number of PRO researchers (about 9,400) but is home to a significantly smaller number of spin-offs. The ratio of spin-offs per researcher is 0.38 for Baden-Wuerttemberg and 0.27 for North-Rhine Westfalia. This does not necessarily imply that spin-off activities at PROs in North-Rhine Westfalia are at a lower level but may also indicate that other regions in Germany are more attractive locations for spin-offs. The highest ratios are reported for Rhineland-Palatine (0.64), Berlin (0.53) and Hesse (0.50). Bavaria (0.43) and Thuringia (0.40) also report above-average spin-off ratios (Figure 18).

Figure 18: Knowledge-based spin-offs from German PROs founded during 2010 and 2019 per researcher, by German states

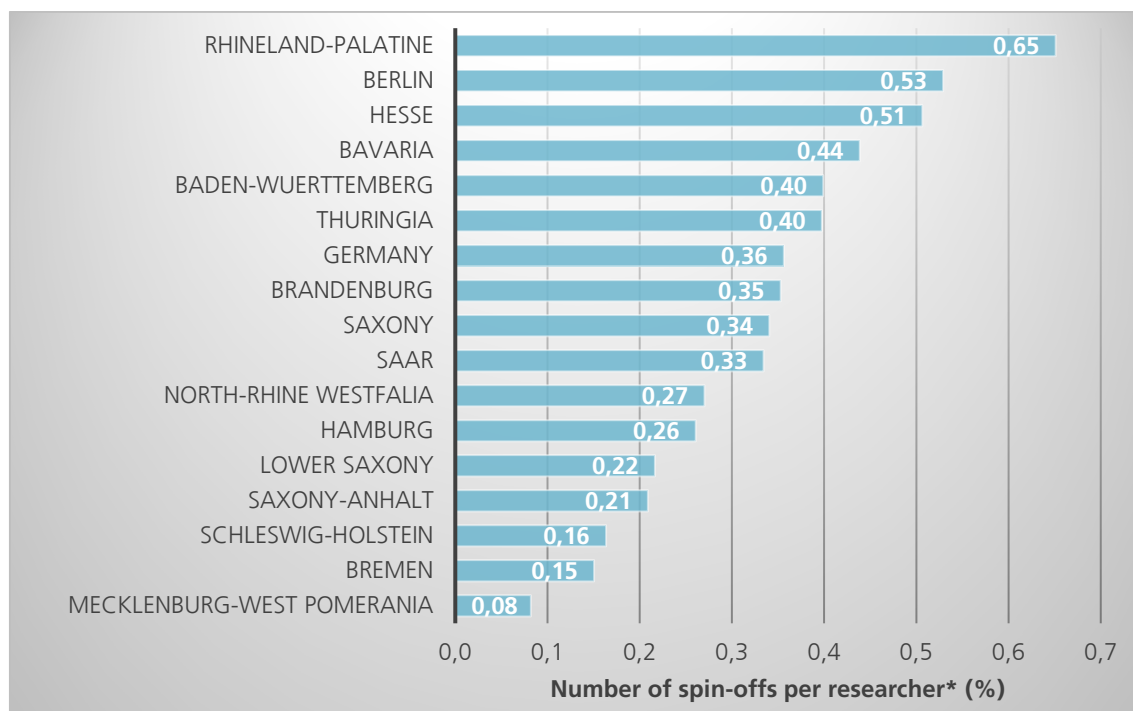

* Number of scientific and technical personnel at full-time equivalents, annual average for the years 2010-2019, ZEW estimation based on Destatis data.

Source: Fraunhofer ISI and ZEW, Destatis.

There are three regions that host one third of all PRO spin-offs in Germany (Table 6): Berlin-Potsdam (15.9%), Munich (incl. the county of Starnberg, 10.6%) and Karlsruhe (6.3%). The high share of Karlsruhe is somewhat surprising and may be linked to a large number of spin-offs by researchers from the Karlsruhe Institute of Technology (KIT) who were previously working at the Research Centre Karlsruhe (FZ Karlsruhe). In such cases, the spin-offs were assigned both to a PRO incubator and to a university incubator.

Table 6: Regions with the largest number of knowledge-based spin-offs from German PROs founded during 2010 and 2019

	No. of spin-offs	Share in all spin-offs (%)
Berlin	277	14.4
Munich City	124	6.4
Karlsruhe City	89	4.6
Dresden	62	3.2
Munich County	60	3.1
Hamburg	54	2.8
Cologne	43	2.2
Frankfurt	41	2.1
Karlsruhe County	33	1.7
Aachen	31	1.6
Leipzig	30	1.6
Potsdam	28	1.5
Düsseldorf	25	1.3
Freiburg	25	1.3
Heidelberg	23	1.2
Starnberg	21	1.1
Dortmund	20	1.0
Mannheim	20	1.0
Stuttgart	19	1.0
Tübingen	19	1.0
Göttingen	17	0.9
Darmstadt	17	0.9
Jena	17	0.9
Bremen	15	0.8
Mainz	15	0.8
Esslingen	15	0.8
Saarbrücken	15	0.8

Regions are defined at the district level (Landkreise, kreisfreie Städte).

Source: Fraunhofer ISI and ZEW

5.2.3 Comparison with Existing Spin-off Lists

The number of spin-offs from German PROs that have been identified in this study clearly exceed the number of spin-offs documented by the headquarters of the PROs. Based on information from each of the four large PROs, the number of documented spin-offs founded during 2010 and 2019 sums up to 468 for the four large PROs. This figure excludes spin-offs located outside Germany as well as spin-offs that are not included in the company register of Creditreform at all or with a founding year outside the focus period of this study.

Table 7: Number of knowledge-based spin-offs from German PROs 2010 to 2019: results of the present study and spin-offs documented by PRO headquarters

	Spin-offs identified in the present study	Spin-offs documented by the PRO headquarters	Ratio of A to B
	A	B	
Fraunhofer Gesellschaft	506	189	2.7
Helmholtz Gemeinschaft	839	173	4.8
Leibniz Gemeinschaft	316	54	5.9
Max-Planck Gesellschaft	455	52	8.8
4 large PROs*	1.925	468	4.1

* For spin-offs identified in the present study, the total for the 4 large PROs is smaller than the sum for the four PROs as some spin-offs are assigned to more than one PRO. There are not multiple assignments of spin-offs documented by the headquarters of PROs.

Source: Fraunhofer ISI and ZEW, GWK Monitoring reports (different editions).

The number of spin-offs identified in the present study exceeds this number by 4.1 times (Table 7). The ratio is particularly high for the Max-Planck Gesellschaft (8.8) and lowest for the Fraunhofer Gesellschaft (2.7).²⁷ This result is not astonishing as spin-offs documented by PRO headquarters mainly include IP-based spin-offs as well as

²⁷ One explanation of this discrepancy between Max-Planck and Fraunhofer is the different publication behaviour and affiliation policy of the organisations. At Max-Planck almost all researchers tend to publish and therefore occur - at one point or another - in the publication database, which is the basis for assigning authors to founders. Fraunhofer researcher show a much lower publication intensity. While the absolute number of publications is not relevant for our identification exercise, the probability that we completely miss researchers at Fraunhofer is much higher than missing Max-Planck researchers. In other words, the staff lists we generate from publications and patents are more comprehensive for Max-Planck than for Fraunhofer, which most probably also leads to a larger underestimation of knowledge-based spin-offs by Fraunhofer than by Max-Planck. Another effect might also emerge from the fact that Max-Planck hosts a large number of researchers that are not on their pay-roll (e.g. visiting researchers, scholarship awardees) that still publish under a Max-Planck affiliation.

research-based spin-offs (based on the definitions discussed in section 2.3) that received public funding during the firm foundation process (e.g. through the EXIST programme or from PRO funds). Expertise-based spin-offs and other spin-offs are usually not documented by PROs, but are likely to represent the largest share of spin-offs identified in the present study.

We received a list of 318 documented spin-offs from the PROs that was merged with the list of spin-offs identified in the present study in order to examine the overlap. The result of this exercise is shown in Table 8. 166 out of 318 documented spin-offs were found in the present study and correctly assigned to the incubator PRO. Another 37 spin-offs were found in the present study, but assigned to another PRO or a university. 115 documented spin-offs were not identified in the present study. In total, 64% of all documented spin-offs were found. This share is higher for spin-offs from the Fraunhofer Gesellschaft and the Helmholtz Gemeinschaft (two thirds each) and lower for spin-offs from the Leibniz Gemeinschaft and the Max-Planck Gesellschaft (59 and 53% respectively).

Table 8: Overlap of PRO knowledge-based spin-offs identified in the present study and spin-offs documented by PRO headquarters

	found and assigned to PRO	found, but not assigned to PRO	not found	Share for found spin-offs
	number of firms			%
Fraunhofer Gesellschaft	43	6	25	66
Helmholtz Gemeinschaft	77	23	47	68
Leibniz Gemeinschaft	23	3	18	59
Max-Planck Gesellschaft	23	5	25	53
4 large PROs	166	37	115	64

Source: Fraunhofer ISI and ZEW.

There are different reasons why the present study did not find all documented spin-offs:

- Some documented spin-offs are founded by researchers that did not publish or patent within the time window for publications and patenting that was used in this study.
- Some documented spin-offs are founded by persons who were not working as researchers at the PRO or university but had a different type of affiliation (e.g. technical staff, student).
- Some documented spin-offs have a legal form (e.g. "Verein" - association) which has been excluded from the analysis in this study.

- Some documented spin-offs are assigned to an industry which has been excluded from the analysis in this study.
- Some documented spin-offs were not founded by individuals, but as a spin-out of the PRO or as a joint venture with another company.

There are a number of structural differences between the documented spin-offs that were found in this study and those that were not. Spin-offs not found tend to be older and are more often not operating any more by the end of 2020. They are more often engaged in research and have a higher share in other technical services, which includes firms focussing on R&D. They are also smaller than the spin-offs found in this study.

Table 9: Overlap of PRO knowledge-based spin-offs identified in the present study and spin-offs documented by PRO headquarters

	found	not found		found	not found
Year of foundation			Industry		
2010	3	8	R&D intensive manufact.	25	16
2011	4	11	Other manufacturing	8	10
2012	5	8	ICT services	27	15
2013	9	13	Other technical services	25	37
2014	9	7	Oth. knowledge-int. serv.	4	5
2015	12	9	All other industries	11	17
2016	13	14	Size (employed persons)		
2017	14	10	1	21	30
2018	19	10	2	13	16
2019	10	10	3 to 4	14	17
Status in 2020			5 to 6	7	6
Still active	92	82	7 to 9	2	8
Closed	5	17	10 to 29	23	13
Not known	2	2	30 to 99	5	4
R&D activity			100 or more	1	1
Research	17	26	not known	14	6
Experimental development	54	50			
Software development	6	4			
None	22	18			

Source: Fraunhofer ISI and ZEW

6 Summary and Conclusions

The Pact for Research and Innovation (PFI) of the period 2021-2030 puts additional emphasis on the transfer of knowledge from science to industry. While patent applications, licensing and spin-offs were specific targets of policies in previous phases of PFI since 2005, new targets have been introduced and the previous ones gained additional attention recently. In general, spin-offs from public research organisations are high on the agenda of policy makers inside and outside of these institutions in Europe and the USA. The numbers of reported spin-offs from many research institutions have been increasing strictly and steadily. The IP-based spin-offs from German PROs have been growing by 7.3% per year in the period 2011-2019, the ones by Fraunhofer even at a rate of 12.7% per year, only outperformed by Stanford University, which reached an average annual growth rate of 13% during this period. The international comparison of IP-based spin-offs from public research organisations and universities revealed that, next to the steep increase of the absolute numbers, German organisations act on a similar level like most of the prestigious international research organisations and universities in Europe and the USA.

Spin-offs are one channel among others to transfer technologies and scientific knowledge from science to industry. Patents and licensing, standards and norms, contract research and a number of other pathways constitute additional channels. In some cases, these transfer channels are in contradiction to each other, for example contract research and the creation of spin-offs might hardly come together at the same time. Spin-offs are still a relevant and attractive transfer mechanism as they are expected to generate innovations, by implementing and diffusing new technologies, by opening-up new markets, or to increase the competitiveness of a country, region or sector, to commercialise technologies, and especially to create new jobs.

To meet these expectations, this is what the interviews revealed, most of the successful spin-off generating organisations do not follow an explicit growth strategy - at least not as a main aim and definitely not at all costs -, but employ a 'quality over quantity' strategy (survival orientation). A sustainable development and the creation of jobs based on a strong business model and passionate founders is what most organisations are looking for. A self-enforcing set-up for entrepreneurial activities in a region or a cluster is what research organisations are aiming at. As universities - and more often than not also research institutes - are central actors in their innovation ecosystems. Out of this rooting in an ecosystem, priorities to generate local impact and to create jobs emerge, which makes them nurture spin-offs that grow into proper businesses. Nurturing an ecosystem, however, takes time, but is worth it as it will create self-reinforcing positive feedback loops that result in a vivid entrepreneurial culture.

IP-based spin-offs are what research organisations are mostly aware of and which they are able to monitor most comprehensively. In addition, universities most often also monitor start-up projects by researchers, students, graduates or even alumni that receive financial or other support in internally or externally funded start-up programs and incubators. Knowledge-based or innovation driven spin-offs, on the other hand, that do not directly built on IP held by the research institution or university is hardly in the scope of the monitoring systems and therefore a large share of the transfer of knowledge from science to industry by the foundation of new companies is invisible. In this study we proposed a method to close this gap of unidentified knowledge-based spin-offs from research organisations and universities by identifying (former) researchers among the founders of start-ups in company databases, namely Creditreform and Hoppenstedt. In absence of complete lists of staff members per research organisations, we used publication and patent data to identify authors and inventors affiliated to research organisation. We developed algorithm-based approaches to reliably match authors/inventors and founders and thereby link start-ups to research institutions, going far beyond IP-based spin-off statistics and enabling us to uncover and analyse a much broader set of knowledge and technology transfer action into spin-offs.

Based on this method we were able to identify 64% of all spin-offs also reported by German PROs. This means, however, two things. First, the method as such is highly suitable to identify knowledge-based spin-offs, but even still underestimates the total output of knowledge-based spin-offs by public research organisations and universities. Even with human instead of automated matching identification rates of about 70% are the maximum, as validation checks of our method have shown. The reason is that not all researchers publish or file a patent in the years prior to the spin-off foundation.

Second, not each and every of the identified companies might be a true positive match. There are still start-ups in our list that are not spin-offs, so a 100% accuracy is not given and also not possible with a quantitative oriented method as it was employed here. The validation measures we took and the cross-checks we made with additional information like web-searches for selected sub-sample makes us very confident that the structural analyses we provide and the empirically based conclusions we draw are highly reliable. The findings based on the dataset of knowledge based spin-offs from the four large public research organisations and the universities in Germany are the following:

- Spin-offs are a relevant channel for transferring research results from PROs.
- Spin-off activities of PROs are at the same level as spin-off activities of universities (i.e. when related to the total number of researchers at each organisation).

- Differences in spin-off activity among the four large PROs are less distinct than for other indicators on knowledge transfer activities such as scientific publications, contract R&D for firms, cooperation projects with firms or patent applications (Table 10). This reflects the fact that a spin-off, in contrast to other transfer channels, is not just a way to transmit research results into commercial use, but it is always also a decision of a researcher about her future carrier path and private life.

Table 10: Indicators on knowledge transfer from PROs and universities in Germany

	Scientific publications per R&D personnel (2013-2015 average)	Financing of R&D by firms per R&D personnel (€1,000, 2017)	Number of cooperation projects with firms per researcher (2017)	Number of patent applications per R&D personnel (2013-2015 average)	Number of spin-offs per researcher (2016-2018 average)
Fraunhofer Gesellschaft	116	41.3	407	33	5.2
Helmholtz Gemeinschaft	455	12.2	50	12	4.2
Leibniz Gemeinschaft	651	5.4	19	7	3.2
Max-Planck Gesellschaft	845	2.8	5	6	4.5
4 large PROs	486	15.9	105	15	3.9
<i>Universities</i>	708	16.2	112	13	3.8

Source: Scopus, Patstat, Mannheim Innovation Panel, Federal Report on Research and Innovation, Destatis, calculation by Fraunhofer ISI and ZEW

- The number of spin-offs identified in this study substantially exceeds the number of spin-offs documented by the headquarters of the four large PROs in Germany. In total we find 1,925 spin-offs by the PROs in the period 2010-2019 and 8,069 by German universities in the same period. For PROs this is more than 4 times the number of officially reported IP-based spin-offs in this period.
- The huge difference (about 4 times higher numbers found in this study) can mainly be attributed to the fact that there are many spin-offs that do not rest on a direct involvement of the PRO (either through shareholding or IP-related contracts) and are hence not monitored by the headquarters of the PROs.
- The number of spin-offs from PROs (and from universities) significantly increased from 2014 on and peaked in 2016/17. Future research will have to show whether

this trend will continue after 2020, and which factors drove the increase in spin-off numbers. It is interesting to note, however, that the growth rates of knowledge-based spin-offs from PROs is slightly lower (4.3%) than for IP-based spin offs (7.3%) - and this hold for all four PROs. One explanation could be that policy action taken by the PROs based on internal and external programs take effect. As they are directly targeting IP-based spin-offs (and funded start-up projects, which are not in the focus of this study), while they might only indirectly reach out to knowledge-based spin-offs as we defined them here, the effects of the efforts differ between the two types of spin-offs.

- The vast majority of spin-offs from PROs (the same is true for university spin-offs) offer services, particularly ICT services, engineering services and R&D services. Less than 1 out of 5 spin-offs belongs to the manufacturing sector.

References

- Bersch, Johannes, Sandra Gottschalk, Bettina Müller and Michaela Niefert (2014), The Mannheim Enterprise Panel (MUP) and Firm Statistics for Germany, ZEW Discussion Paper No. 14-104, Mannheim: Centre for European Economic Research.
- Bessen, J.; Hunt, R. M. (2007): An empirical look at software patents. In: Journal of Economics and Management Strategy 16 (1), S. 157–189.
- Blind, K.; Edler, J.; Friedewald, M. (2005): Software Patents - Empirical Evidence and Policy Implications: Cheltenham: Edward Elgar.
- Carayannis, E.G. and Campbell, D. (2009), "Mode 3' and 'Quadruple Helix': toward a 21st century fractal innovation ecosystem", International Journal of Technology Management, Vol. 46 No. 3/4.
- Crespi, Gustavo; D'Este, Pablo; Fontana, Roberto; Geuna, Aldo (2011): The impact of academic patenting on university research and its transfer. In: Research Policy 40 (1), S. 55–68. DOI: 10.1016/j.respol.2010.09.010.
- Doherr, Thorsten (2021), Disambiguation by Namesake Risk Assessment, ZEW Discussion Paper No. 21-021, Mannheim: Centre for European Economic Research.
- Dornbusch, Friedrich; Neuhäusler, Peter (2015): Academic Patents in Germany. Expertenkommission Forschung und Innovation (EFI). Studien zum deutschen Innovationssystem Nr. 6-2015, Berlin: EFI.
- Egeln, Jürgen, Sandra Gottschalk, Christian Rammer and Alfred Spielkamp (2003), Public Research Spin-offs in Germany, ZEW-Dokumentation No. 03-04, Mannheim: Centre for European Economic Research.
- Frietsch, R.; Lichtblau, Karl; Beckert, Bernd; Daimer, Stephanie; Fritsch, Manuel; Kempermann, Hanno et al. (2016): Elektroindustrie als Leitbranche der Digitalisierung - Innovationschancen und Innovationshemmnisse für die Elektroindustrie. Hg. v. ZVEI-Zentralverband Elektrotechnik-und Elektronikindustrie e. V. Frankfurt.
- Frietsch, R.; Neuhäusler, P.; Melullis, K.-J.; Rothengatter, O.; Conchi, S. (2015): The economic impacts of computer-implemented inventions at the European Patent Office: 4IP Council, Fraunhofer ISI.

- Geuna, Aldo; Nesta, Lionel J. J. (2006): University patenting and its effects on academic research. The emerging European evidence. In: *Research Policy* 35, S. 790–807.
- Graham, S. J. H.; Mowery, D. C. (2005): Software Patents: Good News or Bad News? In: R.W Hahn (Hg.): *Intellectual Property Rights in Frontier Industries: Software and Biotechnology*. Washington, D.C.: AEI-Brookings Joint Center for Regulatory Studies, S. 45–80.
- Hall, B. H.; MacGarvie, M. (2010): The private value of software patents. In: *Research Policy* 39 (7), S. 994–1009.
- Krieger, Bastian, Christian Rammer and Patrick Breithaupt (2020), Identifizierung von Querschnittsthemen in Projekten der Direkten Projektförderung des BMBF, Bundesministerium für Bildung und Forschung, Mannheim: Centre for European Economic Research.
- Lissoni, Francesco; Llerena, Patrick; McKelvey, Maureen; Sanditov, Bulat (2008): Academic Patenting in Europe. New Evidence from the KEINS Database. In: *Research Evaluation* 17 (2), S. 87–102.
- Michels, C.; Schmoch, U. (2012): The growth of science and database coverage. In: *Scientometrics* 93 (3), S. 831–846.
- Neuhäusler, Peter; Rothengatter, Oliver; Frietsch, Rainer (2019): Patent Applications – Structures, Trends and Recent Developments 2018. Expertenkommission Forschung und Innovation (EFI). Studien zum deutschen Innovationssystem, Nr. 4-2019, Berlin: EFI.
- Nosella, A. and Grimaldi, R. (2009), “University-level mechanisms supporting the creation of new companies: an analysis of Italian academic spin-offs”, *Technology Analysis & Strategic Management*, Vol. 21 No. 6, pp. 679–698.
- Stahlschmidt, S.; Stephen, D.; Hinze, S. (2019): Performance and Structures of the German Science System, Expertenkommission Forschung und Innovation (EFI). Studien zum deutschen Innovationssystem No. 5-2019, Expertenkommission, Berlin: EFI.